

Hydraulic High Pressure Controller, Model CPC8000-H

EN



Hydraulic High Pressure Controller, Model CPC8000-H



Smart in sensing

© 03/2024, Mensor, LP. All rights reserved.

Mensor is a registered trademark of Mensor, LP.

All other brand and product names are trademarks or registered trademarks of their respective companies.

Prior to starting any work, read the operating instructions!

Keep for later use!

Contents

1. General Information	7
1.1 Warranty	8
1.2 Radio Frequency Emission Notices	8
1.2.1 FCC Emission Notice	8
1.2.2 CE Emission Notice	8
1.3 Software License Agreement	8
1.4 Mensor Service Plus	9
1.4.1 After the Warranty	9
1.4.2 Calibration Services	9
1.4.3 Certifications and Accreditations	9
2. Short Overview	10
2.1 Features	10
2.2 Components	11
2.2.1 CPC8000-HC pneumatic pressure controller	11
2.2.2 CPC8000-HM hydraulic module	11
2.3 Turning On	11
2.4 Front Panel	12
2.4.1 Power Switch	12
2.4.2 USB Port	12
2.5 Display	13
2.6 Scope of Delivery	13
3. Safety	14
3.1 Explanation of Symbols	14
3.2 Intended Use	14
3.3 Improper Use	15
3.4 Responsibility of the Operator	15
3.5 Personnel Qualification	15
3.6 Personal Protective Equipment	16
3.7 Labeling, Safety Marks	16
3.7.1 Product Label	16
3.7.2 Symbols	16
3.8 Warnings and Cautions	17
4. Transport, Packaging and Storage	18
4.1 Transport	18
4.2 Packaging and storage	18
5. Installation	19
5.1 Mounting	19
5.2 Rear Panel	19
5.2.1 Pressure ports	19
5.2.1.1 CPC8000-HC	20
5.2.1.2 CPC8000-HM	20
5.2.2 Communication ports	21
5.2.2.1 USB host	21
5.2.2.2 Interface port	21
5.2.3 Power inlet	21
5.2.4 Measure/Control test port prefilling	22
6. Operation	23
6.1 General Operation	23

6.1.1	Power Up	23
6.1.2	Setup Applications	24
6.1.3	Display Screen Features	25
6.2	Initial Setup.	25
6.2.1	Information Application.	26
6.2.2	Language Selection	26
6.3	Application Selection and Parameter Inputs.	26
6.4	Applications	27
6.4.1	Main Screen	27
6.4.1.1	Range Hold	27
6.4.1.2	Setpoint	28
6.4.1.2.1	Numeric Pad	28
6.4.1.2.2	Number Pad Step	29
6.4.1.2.3	Percent Step	29
6.4.1.2.4	Digit Step	30
6.4.1.2.5	Programs.	30
6.4.1.3	Favorites	31
6.4.1.4	Units and Pressure Type.	31
6.4.1.5	Bar Graph and Control Limits	32
6.4.1.6	Auxiliary Displays	33
6.4.1.7	Operating Modes	33
6.4.1.7.1	Measure Mode.	33
6.4.1.7.2	Control Mode	34
6.4.1.7.3	Vent Mode	36
6.4.1.8	Status Bar and Barometer Reading	37
6.4.2	Settings	38
6.4.2.1	General Settings	38
6.4.2.1.1	Languages	39
6.4.2.1.2	Auxiliary Displays	39
6.4.2.1.3	Cal Function.	40
6.4.2.1.4	Brightness	41
6.4.2.1.5	Volume	41
6.4.2.1.6	Barometer	42
6.4.2.1.7	Load/Save	42
6.4.2.2	Sensor Settings.	43
6.4.2.2.1	Filter	43
6.4.2.2.2	Resolution	44
6.4.2.2.3	Units	44
6.4.2.2.4	User Units and Multiplier Settings	44
6.4.2.3	Control Settings	45
6.4.2.3.1	Maximum and Minimum Limits	45
6.4.2.3.2	Stable Limits and Delay	46
6.4.2.3.3	Vent Limit	47
6.4.2.3.4	Tank Pump	47
6.4.2.4	Remote Settings	48
6.4.2.4.1	Command Set	48
6.4.2.4.2	Termination Character	48
6.4.2.4.3	IEEE-488 Address	49

6.4.2.4.4	Ethernet Settings	49
6.4.2.4.5	Serial Settings	50
6.4.2.5	Applications	50
6.4.2.5.1	1 Point Calibration.	51
6.4.2.5.2	2 Point Calibration.	52
6.4.2.5.3	Linearize	56
6.4.2.5.4	Head Correction	57
6.4.2.5.5	Programs.	57
6.4.2.5.6	Favorites	58
6.4.2.5.7	Troubleshoot	59
6.4.2.5.8	Software	59
6.4.2.5.9	Hydraulic	60
6.4.2.5.10	Tune	61
6.4.2.5.11	Admin	62
6.4.2.5.12	Troubleshooting	62
7.	Remote Operation	64
7.1	Remote Operating Parameters	64
7.2	Command Set.	64
7.3	IEEE-488	64
7.3.1	IEEE-488.2 Commands	64
7.4	Ethernet.	64
7.5	Serial.	65
7.5.1	Serial Cable Requirements	65
7.6	Mensor Command Set	66
7.6.1	Command and Query Format	66
7.6.2	Command Set Definitions	66
7.6.3	Output Formats	66
7.6.4	Mensor Commands and Queries	67
7.7	Wika SCPI Command Set.	80
8.	Maintenance and Recalibration	84
8.1	Maintenance	84
8.1.1	Beyond the Warranty	84
8.1.2	Hydraulic Media Filling	84
8.1.3	Transducer Removal	85
8.2	Recalibration	86
8.2.1	Calibration Services by Mensor or WIKA Worldwide	87
8.2.2	Environment	87
8.2.3	Pressure Standards	87
8.2.4	Media	87
8.2.5	Setup.	88
8.2.6	Calibration data	88
9.	Dismounting, Return and Disposal	89
9.1	Dismounting	89
9.2	Return	90
9.3	Disposal.	90
10.	Specifications	91
10.1	Measurement Specification	91
10.2	Approvals and Certificates	93
10.3	Dimensions in mm (in)	93

Contents

EN

10.3.1	CPC8000-H with optional rolling rack	94
10.3.2	CPC8000-HM hydraulic module.	95
10.3.3	CPC8000-HC pneumatic controller (inches)	96
11.	Accessories	97
11.1	Barometric Reference Sensor	97
11.1.1	Emulation Mode Accuracy	97
11.1.2	Barometric Reference Calibration	97
11.2	Barometric Reference Calibration Sled	97
11.3	Reference Pressure Calibration Sled	97
11.3.1	CPR8000 Reference Calibration Sled	98
11.3.2	CPR8050 and CPR8850 reference pressure calibration sled	98
11.4	Operating fluid	98
12.	Appendix	99
12.1	Measurement Units	99
12.2	Conversion Factors, PSI	100

Declarations of conformity can be found online at www.wika.com.

PN 0018708001J 03 / 2024 EN

1. General information

1. General Information

- The CPC8000-H hydraulic high pressure controller described in the operating instructions has been designed and manufactured using state-of-the-art technology. All components are subject to stringent quality and environmental criteria during production. Our management systems are certified to ISO 9001.
- These operating instructions contain important information on handling the instrument. Working safely requires that all safety instructions and work instructions are observed.
- Observe the relevant local accident prevention regulations and general safety regulations for the instrument's operating range.
- The operating instructions are part of the instrument and must be kept in the immediate vicinity of the instrument and readily accessible to skilled personnel at any time. Pass the operating instructions onto the next operator or owner of the instrument.
- Skilled personnel must have carefully read and understood the operating instructions prior to beginning any work.
- The general terms and conditions contained in the sales documentation shall apply.
- Factory calibrations / A2LA / DKD/DAkkS calibrations are carried out in accordance with international standards.
- Further information:

Mensor Corporation

- Address: 201 Barnes Dr., San Marcos, TX 78666
- Internet address: www.mensor.com
- Relevant data sheet: CT 32.05
- Application consultant: Tel.: (+1) 512-396-4200
(+1) 800-984-4200 (USA only)
Fax: (+1) 512-396-1820
E-Mail: sales@mensor.com

Importer for Europe and UK

WIKA Alexander Wiegand SE & Co. KG

- Address: Alexander Wiegand-Straße
63911 Klingenberg, Germany
- Internet address: www.wika.de / www.wika.com
- Relevant data sheet: CT 32.05
- Application consultant: Tel.: (+49) 9372/132-5015
Fax: (+49) 9372/132-8767
E-Mail: CTsales@wika.com

WIKA Instrument Ltd

- Address: The Moor Road, Sevenoaks Kent,
TN15 5GY
- Internet Address: www.wika.com/en-us
- Relevant data sheet: CT 32.05
- Application consultant: (+1) - 888-945-2872

1.1 Warranty

All products manufactured by Mensor are warranted to be free of defects in workmanship and materials for a period of two years from the date of shipment. No other express warranty is given, and no affirmation of Seller, by words or actions, shall constitute a warranty. SELLER DISCLAIMS ANY IMPLIED WARRANTIES OF MERCHANTABILITY OR FITNESS FOR ANY PARTICULAR PURPOSES WHATSOEVER. If any defect in workmanship or material should develop under conditions of normal use and service within the warranty period, repairs will be made at no charge to the original purchaser, upon delivery of the product(s) to the factory, shipping charges prepaid. If inspection by Mensor or its authorized representative reveals that the product was damaged by accident, alteration, misuse, abuse, faulty installation or other causes beyond the control of Mensor, this warranty does not apply. The judgment of Mensor will be final as to all matters concerning condition of the product, the cause and nature of a defect, and the necessity or manner of repair. Service, repairs or disassembly of the product in any manner, performed without specific factory permission, voids this warranty.

MENSOR MAKES NO WARRANTY OF ANY KIND WITH REGARD TO THIS MANUAL, INCLUDING, BUT NOT LIMITED TO, THE IMPLIED WARRANTIES OF MERCHANTABILITY AND FITNESS FOR A PARTICULAR PURPOSE. Mensor shall not be liable for errors contained herein or for incidental or consequential damages in connection with the furnishing, performance, or use of this material.

1.2 Radio Frequency Emission Notices



USE SHIELDED CABLES TO CONNECT EXTERNAL DEVICES TO THIS INSTRUMENT TO MINIMIZE RF RADIATION

1.2.1 FCC Emission Notice

This equipment has been tested and found to comply with the limits for a Class A digital device, pursuant to part 15 of the FCC Rules. These limits are designed to provide reasonable protection against harmful interference when the equipment is operated in a commercial environment. This equipment generates, uses, and can radiate radio frequency energy and, if not installed and used in accordance with the instruction manual, may cause harmful interference to radio communications. Operation of this equipment in a residential area is likely to cause harmful interference in which case the user will be required to correct the interference at his or her own expense.

1.2.2 CE Emission Notice

This equipment is of the emission class A, intended for operation in industrial environments. It can cause interference under certain circumstances if operated in other environments, i.e. residential or commercial areas. In this case, the user may be asked to take appropriate measures to correct it.

1. General Information

1.3 Software License Agreement

This product contains intellectual property, i.e. software programs, that are licensed for use by the end user/customer (hereinafter “end user”).

This is not a sale of such intellectual property.

The end user shall not copy, disassemble or reverse compile the software program.

EN



The software programs are provided to the end user “as is” without warranty of any kind, either express or implied, including, but not limited to, warranties of merchantability and fitness for a particular purpose. The entire risk of the quality and performance of the software program is with the end user.

Mensor and its suppliers shall not be held to any liability for any damages suffered or incurred by the end user (including, but not limited to, general, special, consequential or incidental damages including damages for loss of business profits, business interruption, loss of business information and the like), arising from or in connection with the delivery, use or performance of the software program.

1.4 Mensor Service Plus

1.4.1 After the Warranty

Mensor’s concern with the performance of this instrument is not limited to the warranty period. We provide complete repair, calibration and certification services after the warranty for a nominal fee.

1.4.2 Calibration Services

In addition to servicing our own products Mensor can perform a complete pressure calibration service, up to 30,000 psi, for all of your pressure instruments. This service includes an accredited calibration.

1.4.3 Certifications and Accreditations

Mensor is registered to ISO 9001:2015. The calibration program at Mensor is accredited by A2LA, as complying with both the ISO/IEC 17025:2017 and the ANSI/NCSL Z540-1-1994 standards.

2. Short Overview

2. Short Overview

The CPC8000-H hydraulic high pressure controller is a multi-range automatic pressure controller designed to test and calibrate a variety of pressure devices such as pressure gauges, pressure switches, sensors, transducers and transmitters. It can have up to two internal pressure reference transducers and an optional barometric reference for gauge or absolute emulation. The CPC8000-H works with a supply pressure of nitrogen or dry, clean air and uses an intensifier assembly to convert this force to hydraulic pressure. It comes in three different versions, the CPC8000-HM-L which has a 1:20 pneumatic to hydraulic ratio, and the CPC8000-HM-M, which has a 1:56 ratio.

EN

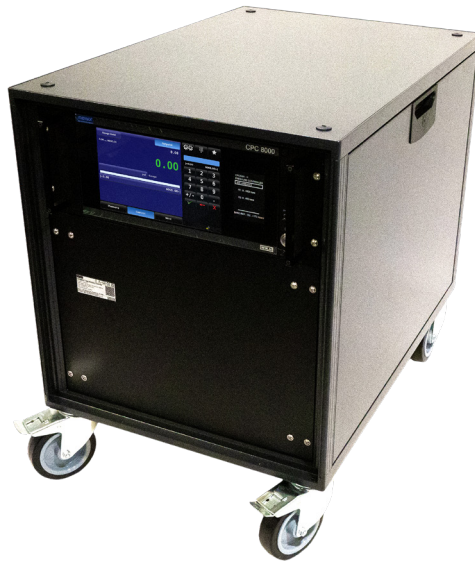

Figure 2.1 CPC8000-H with Rolling Rack

2.1 Features

Here is a short list of significant features designed into the CPC8000-H:

- Optional 19" rack cabinet with casters
- Operating range from 0... 700 bar (10,000 psi) for CPC8000-H-LP, 0 ... 1,600 bar (23,000 psi) for CPC8000-H-MP, and 0 ... 4,000 bar (58,000 psi) for CPC8000-H-EP
- Two removable transducers with up to 0.008% IS-33 measurement accuracy
- An optional removable / interchangeable internal high accuracy barometric reference transducer providing emulation for both absolute and gauge pressure ranges
- 10.1" diagonal color TFT with touch screen
- Ethernet, RS-232, USB and IEEE-488 communications
- Multiple languages; change the language for on-screen text and number/date formats by simply touching one of the "national flag" icons available in the setup screen.
- Multiple media capabilities. (Oil, water, and a variety of others upon request)

PN 0018708001J 03 / 2024 EN

2. Short overview

2.2 Components

2.2.1 CPC8000-HC pneumatic pressure controller

The CPC8000-HC is composed of:

- A CPC8000 pneumatic pressure controller
- A pneumatic pilot transducer
- Optional internal barometric reference transducer
- Touchscreen interface for local operation
- Communication ports on rear panel for remote operation
- Programmable sequences for automated calibration

EN



Figure 2.2.1 CPC8000-HC 1

2.2.2 CPC8000-HM hydraulic module

The CPC8000-HM is the housing for the intensifiers and reference pressure transducers. This module consists of:

- Two intensifiers working in parallel for quick control and larger volumes
- Priming pump to ensure the DUT and intensifiers are purged
- Media reservoir tank with sight glass for maintaining an optimal fluid level
- Filling nozzle for easy refilling of the hydraulic media. (Sebacate, Shell Tellus and distilled water. Consult factory for other media)

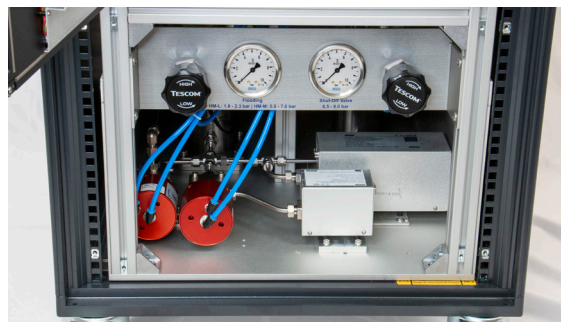

Figure 2.2.2 CPC8000-HM

2.3 Turning On

Apply power to the power connector on the rear panel of the CPC8000-HC with the included power cord and press the power switch to ON. The system will go through an initialization process, which takes about 1 minute, and then a display will appear similar to the screen shown below. The instrument must be powered on for a minimum of 60 minutes to allow for best system accuracy.

2. Short overview

EN



Figure 2.3 Power Button



Earth Ground! Any power adapters or surge protection devices that negate the protective earth ground should not be used. The power cord must be accessible and contain a protective earth ground. Do not position the equipment so that it is difficult to remove the power cord.

To see information about the configuration of your new CPC8000-H, touch the Info button under the settings menu and a window will appear listing the Mensor contact information, model number and the transducers that are installed. Press the back arrow to return to the Home screen.



Figure 2.3 Information application

2.4 Front Panel

The CPC8000-H front panel includes a 10.1" diagonal color TFT display with touch screen. Operator input is accomplished by pressing the words or symbols and the icons presented on the display. There is a single discrete on/off button and a USB port on the right hand side. The front panel also shows the model number designation, pressure ranges and brand logos.

2.4.1 Power Switch

The power switch is a two-state device with an action similar to that of a ball point pen. Push the button with enough force to latch it in to turn the unit ON. Push it again to release it to turn the system OFF.



If power to the instrument is interrupted while ON it will shut down until the power is restored, then immediately resume operation.

2.4.2 USB Port

The front panel USB port is the Host USB and is intended for software upgrades. Section 6 Operation explains this in detail.

2. Short overview

2.5 Display

The display is made up of two sections. In the main screen, the left two thirds shows the operating screen displaying the active pressure reading, units, mode (absolute or gauge), setpoint, bar graph (if enabled), zero button (if enabled), tare button (if enabled), and up to two auxiliary displays that are user selectable. At the bottom of this section are three control modes: Measure, Control and Vent. The right one third of the screen has the Settings button, Keypad button and Favorites button. The Settings button will take the user to a new screen with all the setting applications. The Keypad button will display a numberpad with all the buttons needed to input values. The Favorites button will display the sequences that have been set up as favorites by the user. On the bottom of this section is the optional barometric pressure reading, and remote and troubleshooting alerts.

EN

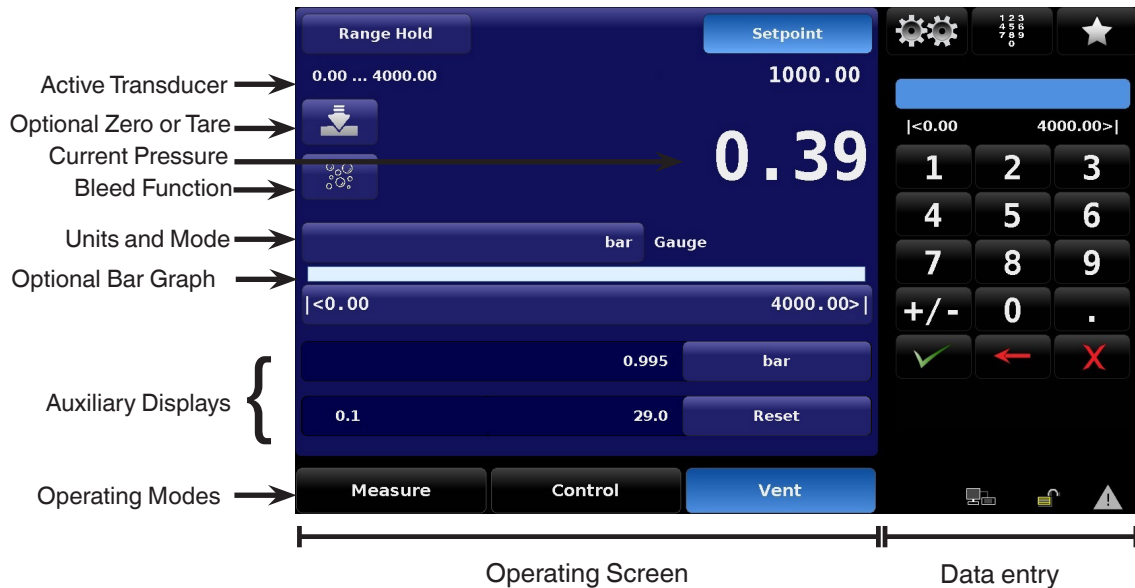

Buttons, Labels and Windows: The CPC8000-H touch screen has many buttons with relevant graphic icons or text which, when touched, will open a related window where changes can be made or information viewed. Some of these buttons will toggle from one state to another, others present choices or display a numerical data entry screen. Text or icons that are displayed, but do not respond to being touched, are called labels or windows. Operators will quickly become accustomed to the particular characteristics of the frequently used buttons.

Main Screen: The main screen appears after power-up. It will remain as configured after a power cycle.

Operating screen: The operating screen (left 2/3 of the main screen) contains information relevant to the pressure measurement. Up to two auxiliary displays can be shown simultaneously along with the current pressure value

2.6 Scope of Delivery

- CPC8000-HC pneumatic controller
- CPC8000-HM hydraulic module
- 19" rack cabinet with casters (optional)
- Power cord (1.5 m/ 5 ft. length)
- Operating Instructions
- Factory Calibration Certificate
- 1/4" HP cone and threaded connection for the Measure Control/DUT port
- 6mm to 1/4" adapter for Supply port

Cross-check scope of delivery with delivery note.

3. Safety

3. Safety

3.1 Explanation of Symbols

EN



DANGER!

... indicates a directly dangerous situation resulting in serious injury or death, if not avoided.



WARNING!

... indicates a potentially dangerous situation that can result in serious injury or death, if not avoided.



CAUTION!

... indicates a potentially dangerous situation that can result in light injuries or damage to property or the environment, if not avoided.



DANGER!

... identifies hazards caused by electrical power. Should the safety instructions not be observed, there is a risk of serious or fatal injury.



WARNING!

... indicates a potentially dangerous situation that can result in burns, caused by hot surfaces or liquids, if not avoided.



Information

... points out useful tips, recommendations and information for efficient and trouble-free operation.

3.2 Intended Use

The CPC8000-H hydraulic high pressure controller is designed to automate the testing and calibration of pressure devices and instruments for pressures up to 1,600 bar or 23,000 psi. Up to two removable/interchangeable pressure transducers are available in full scale (FS) ranges from 1,500 to 23,000 psi (100 to 1,600 bar). Each transducer is configured with its own calibration parameters on board. Accuracies are available with 0.008% up to 6,000 psi, 0.01% up to 10,000 psi, 0.014% up to 23,000 psi. In addition to the two active range transducers, a barometric reference is also available as an option. With this option enabled, the CPC8000-H can emulate both gauge and absolute pressures. The CPC8000-H requires a pneumatic supply pressure of 35 bar which it uses to control the hydraulic pressure output through an intensifier mechanism. The CPC8000 uses a 35 bar pneumatic transducer to monitor this pilot pressure.

This instrument is not permitted to be used in hazardous areas!

The instrument has been designed and built solely for the intended use described here, and may only be used accordingly.

The technical specifications contained in these operating instructions must be observed. Improper handling or operation of the instrument outside of its technical specifications requires the instrument to be taken out of service immediately and inspected by an authorized WIKA/Mensor service engineer.

Handle electronic precision measuring instruments with the required care (protect from humidity, impacts, strong magnetic fields, static electricity and extreme temperatures, do not insert any objects into the instrument or its openings). Plugs and sockets must be protected from contamination.

The manufacturer shall not be liable for claims of any type based on operation contrary to the intended use.

3.3 Improper Use



WARNING!

Injuries through improper use

Improper use of the instrument can lead to hazardous situations and injuries.

- ▶ Refrain from unauthorized modifications to the instrument.
- ▶ Do not use the instrument within hazardous areas.
- ▶ Do not use the instrument with materials and mixtures of the group 1 (hazardous fluids) according Regulation (EC) no. 1272/2008.
- ▶ Use only hydraulic media specified in user manual. (Consult factory for non-specified media)

Any use beyond or different to the intended use is considered as improper use. Do not use this instrument in safety or emergency stop devices.

3.4 Responsibility of the Operator

The instrument is used in the industrial sector. The operator is therefore responsible for legal obligations regarding safety at work.

The safety instructions within these operating instructions, as well as the safety, accident prevention and environmental protection regulations for the application area must be maintained.

The operator is obliged to maintain the product label in a legible condition.

To ensure safe working on the instrument, the operating company must ensure that

- suitable first-aid equipment is available and aid is provided whenever required.
- the operating personnel are regularly instructed in all topics regarding work safety, first aid and environmental protection and know the operating instructions and in particular, the safety instructions contained therein.
- the instrument is suitable for the particular application in accordance with its intended use.
- personal protective equipment is available.

3.5 Personnel Qualification



WARNING!

Risk of injury should qualification be insufficient

Improper handling can result in considerable injury and damage to equipment.

- ▶ The activities described in these operating instructions may only be carried out by skilled personnel who have the qualifications described below.

Skilled personnel

Skilled personnel, authorized by the operator, are understood to be personnel who, based on their technical training, knowledge of measurement and control technology and on their experience and knowledge of country-specific regulations, current standards and directives, are capable of carrying out the work described and independently recognizing potential hazards.

Operating personnel

The personnel trained by the operator are understood to be personnel who, based on their education, knowledge and experience, are capable of carrying out the work described and independently recognizing potential hazards.

Special knowledge for working with instruments for hazardous areas:

The skilled (electrical) personnel must have knowledge of ignition protection types, regulations and provisions for equipment in hazardous areas.

Special operating conditions require further appropriate knowledge, e.g. of aggressive media.

3. Safety

3.6 Personal Protective Equipment

The personal protective equipment is designed to protect the skilled personnel from hazards that could impair their safety or health during work. When carrying out the various tasks on and with the instrument, the skilled personnel must wear personal protective equipment.

EN

Follow the instructions displayed in the work area regarding personal protective equipment!

The requisite personal protective equipment must be provided by the operating company.



Wear clean and protective safety glasses!

3.7 Labeling, Safety Marks

3.7.1 Product Label

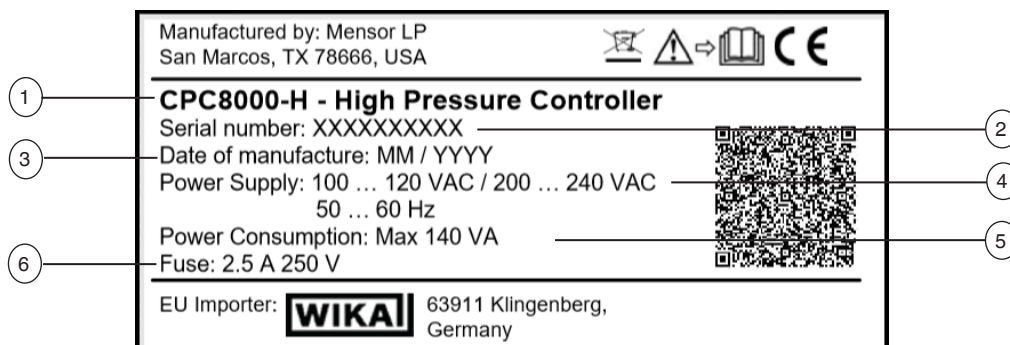

① Model

② Serial number

③ Date of manufacturing

④ Power supply

⑤ Power consumption

⑥ Fuse

3.7.2 Symbols



Before mounting and commissioning the instrument, ensure you read the operating instructions!



CE, Communauté Européenne

Instruments bearing this mark comply with the relevant European directives.



This marking on the instruments indicates that they must not be disposed of in domestic waste. The disposal is carried out by return to the manufacturer or by the corresponding municipal authorities (see EU directive 2012/19/EU).



UKCA Declaration of Conformity

Instruments bearing this mark comply with the relevant UK directives.

3. Safety

3.8 Warnings and Cautions



WARNING!

HIGH PRESSURE! High pressure liquids and gases are potentially hazardous. Energy stored in these gases and liquids can be released suddenly and with extreme force. High pressure systems should be assembled and operated only by personnel who have been trained in proper safety practices.

EN



WARNING!

NOT EXPLOSION PROOF! Installation of this instrument in an area requiring devices rated as intrinsically safe is not recommended.



WARNING!

POSSIBLE INJURY! The tubing, valves, and other apparatus attached to the controller must be adequate for the maximum pressure which will be applied, otherwise physical injury to the operator or bystanders is possible.



CAUTION

USE THE PROPER PRESSURE MEDIUM! Use only clean, dry air or nitrogen for the CPC8000-HC and only specified medium on the CPC8000-HM unless otherwise specified by Mensor.



CAUTION

As with most sensitive electronic equipment, switch the power switch off before connecting or disconnecting to a power source to prevent data loss. Do not position the equipment so that it is difficult to disconnect the AC power cord.



WARNING!

Use the originally delivered power supply cord only! If not possible, contact us or use a certified power cord with ratings according to Section 10. Specifications for power ratings.



WARNING!

POSSIBLE INJURY! Personnel should not be in close proximity to the vent port during venting.

Additional Warning and Caution notices are found throughout this manual.

4. Transport, Packaging and Storage

4. Transport, Packaging and Storage

4.1 Transport

EN Check the hydraulic high pressure controller CPC8000-H for any damage that may have been caused by transport. Obvious damage must be reported immediately.



CAUTION!

Damage through improper transport

With improper transport, a high level of damage to property can occur.

- ▶ When unloading packed goods upon delivery as well as during internal transport, proceed carefully and observe the symbols on the packaging.
- ▶ With internal transport, observe the instructions in chapter 4.2 "Packaging and storage".



WARNING!

Physical injuries to personnel caused by heavy weight

Carefully follow all transport, packaging and storage instructions to prevent injuries caused by the weight of the CPC8000-H.

If the instrument is transported from a cold into a warm environment, the formation of condensation may result in instrument malfunction. Before putting it back into operation, wait for the instrument temperature and the room temperature to equalize.

4.2 Packaging and storage

If the CPC8000-H is purchased **with** the optional 19" rack, then the instrument will be packaged inside a custom crate and strapped down to a pallet.

If the CPC8000-H is purchased **without** the optional 19" rack, the instrument will be strapped down on a single pallet with the CPC8000-HM (hydraulic module) on the bottom and the CPC8000-HC (pneumatic controller) on top.

Permissible conditions at the place of storage:

- Storage temperature: 5 ... 70 °C
- Humidity: 0 ... 95 % relative humidity (no condensation)

Avoid exposure to the following factors:

- Direct sunlight or proximity to hot objects
- Mechanical vibration, mechanical shock (putting it down hard)
- Soot, vapor, dust and corrosive gases
- Hazardous environments, flammable atmospheres
- Direct exposure to air vent

5. Installation

Personnel: Skilled electrical and mechanical personnel

The following instructions must be followed in setting up the instrument for the first and any time after transporting to a different location



WARNING!

READ THESE INSTRUCTIONS BEFORE INSTALLATION!



WARNING!

Physical injuries and damage to property and the environment caused by hazardous media

Upon contact with hazardous media (e.g. oxygen, acetylene, flammable or toxic substances), harmful media (e.g. corrosive, toxic, carcinogenic, radioactive), and also with refrigeration plants and compressors, there is a danger of physical injuries and damage to property and the environment.

Should a failure occur, aggressive media with extremely high temperature and under high pressure may be present at the instrument.

- ▶ For these media, in addition to all standard regulations, the appropriate existing codes or regulations must also be followed.
- ▶ Wear the requisite protective equipment (see chapter 3.6 “Personal protective equipment”).



CAUTION

Damage to the instrument

When working on open electrical circuits (printed circuit boards) there is a risk of damaging sensitive electronic components through electrostatic discharge.

- ▶ The correct use of grounded working surfaces and personal armbands is required.

5.1 Mounting

If ordered **without** a rolling rack and casters, it should be installed on a stable surface. Avoid mounting the instrument on surfaces subject to motor or machinery vibration. Keep the instrument far away from doors, windows, heating systems and air conditioning vents.

The CPC8000-H can optionally be installed in a rack with casters. It should be stationed away from any vibrations and changing air flow and the casters should be locked into place.



CAUTION

Avoid any vibrations and direct solar rays. Any significant temperature fluctuations can make the instrument unstable. Do not use the CPC8000-H in explosive atmospheres, permanently humid or dusty environments.

5.2 Rear Panel

The complete rear panel of the CPC8000-H consists of two independent modules, the CPC8000-HC pneumatic module and the CPC8000-HM hydraulic module. There are a total of 9 pressure ports, 6 communication ports, and a power inlet.

5.2.1 Pressure ports



WARNING!

All pressure ports should be vented before disconnected.

While changing any pressure port on the CPC8000-H, the pressure should be fully vented and the source should be turned off.



WARNING!

Use the proper equipment and tooling for pressure connections.

Ensure that all tooling and process connections are appropriate for the pressure connection. Never use the wrong connector or tool while fastening a pressure port fitting or connector.

5. Installation

5.2.1.1 CPC8000-HC

The CPC8000-HC module has 6 pressure ports: barometric reference, supply, exhaust, vent, reference, and measure/control port.

EN

- The barometric reference port uses a barb fitting with a 10-32 unf thread. This port is used to monitor atmospheric pressure when the optional barometric reference transducer is installed.
- The supply port uses a 7/16" SAE female thread. This port is required to have approximately 100 to 110 % of the pilot pressure range: 35-46 bar depending on the version.
- The exhaust port uses a 7/16" SAE female thread. This port is not used in the CPC8000-H model.
- The vent port uses a 7/16" SAE female thread. This port is used during control and vent mode to relieve pressure from the instrument.
- The reference port uses a 7/16" SAE female thread. This port is not used in the CPC8000-H model.
- The measure/control port uses a 7/16" SAE female thread. This port is used to link the CPC8000-HC to the hydraulic module. This provides the air supply to the intensifier while in control mode.

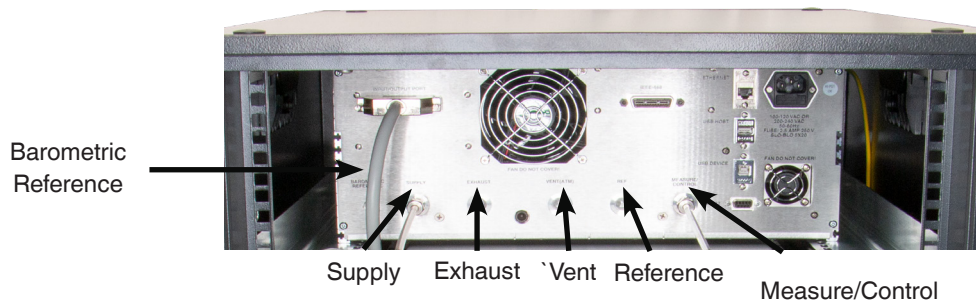

5.2.1.2 CPC8000-HM

The CPC8000-HM contains 3 ports: the drive air, measure/control CPC8000-HC, and measure/control DUT.

- The pneumatic supply pressure uses a male 6mm tube fitting. This port requires at least 8 bar (115 psi) of pressure, but it can also use up to the full supply pressure of the CPC8000-HC. This pressure is used to actuate the isolation valves and priming pump located within the hydraulic module.
- The measure/control CPC8000-HC port uses a male 6mm tube fitting. This port must be connected to the CPC8000-HC measure/control port. It is used to supply air pressure to the intensifiers using the provided tubing.
- The measure/control DUT port uses a female 1/4 HP cone and threaded connection. Consult factory for different adapters. This port is used to control hydraulic pressure on the DUT.

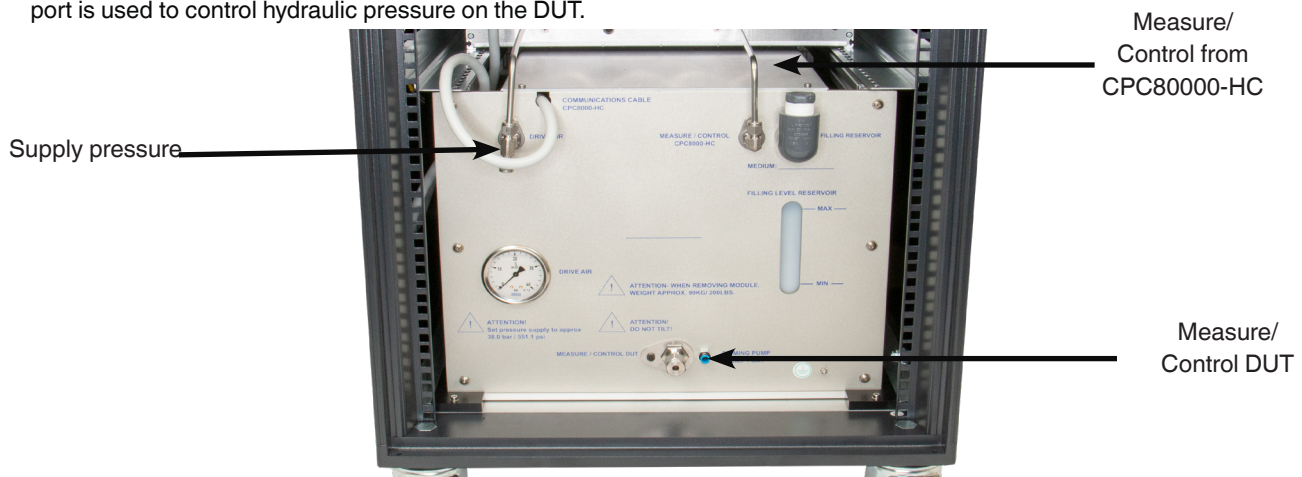

WARNING!

Do not use the instrument without the Measure/Control port connected.

Be sure to always have the Measure/Control port connected to a test sample while using the CPC8000-H. If the test port is left open or disconnected, liquid can leak from the instrument.

5. Installation



WARNING!

Never disconnect test ports while pressurized!

Be sure the instrument is fully vented and the source pressure is turned off while disconnecting connections and hoses from the Measure/Control port. Failure to disassemble the test ports correctly could result in leaking liquids and gasses.



WARNING!

Do not exceed the maximum source pressure!

The supply pressure port is limited to 110% over the primary pilot transducer range. Do not exceed this pressure rating labeled on the back of the instrument.

EN

5.2.2 Communication ports

The CPC8000-H has 6 communication ports, all located on the CPC8000-HC: IEEE-488, USB device, RS-232, Ethernet, USB host and an interface port to communicate between the two modules. See section 8, Remote Operation, for connections and commands for operation over IEEE-488, Ethernet, USB or RS232 ports.

5.2.2.1 USB host

The USB host port is intended for future expansions or software upgrades. This port can also be accessed through the front panel.

5.2.2.2 Interface port

The interface port is a direct communication between the CPC8000-HC module and the CPC8000-HM. This provides the feedback information from the hydraulic module transducers. The interface cable is permanently fixed to the CPC8000-HM and can be removed from the CPC8000-HC using a slotted screwdriver.

5.2.3 Power inlet

Apply power with the included power cable to the rear power inlet port on the CPC8000-HC. This port is equipped with two 2.5 amp 250V Slo-Blo fuses and is rated at 100 - 120 VAC or 200 - 240 VAC at 50 / 60 Hz.

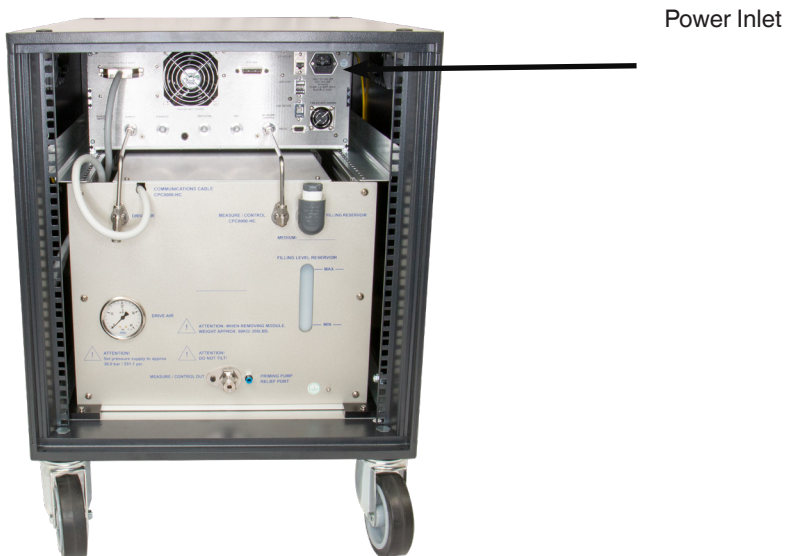

Figure 5.2.3 Power Inlet



DANGER!

Use caution when dealing with power cable and inlet connection. Hazard of electric shock: warning notice according to IEC 61010-1.

5. Installation

5.2.4 Measure/Control test port prefilling

The Device Under Test must be filled with the hydraulic media to perform to the rated specifications. If there is not an designed user designed method to prefill the DUT, the following method may be used.

1. Install the test device and tubing to the Measure/Control port of the CPC8000-H.
2. Loosen a fitting furthest away from the CPC8000-H Measure/Control port.
3. Connect pressure to the Supply port and power on the CPC8000-H
4. Navigate to the Hydraulic App (See Section 6.4.2.5.9)
5. Select the Measure button and then press the pump button. The pump within the CPC8000-HM will fill the volume with fluid. A mixture of air and liquid will leak out the loosened fitting. [Figure 5.2.4]
6. Continue pumping until only liquid is leaking from the loosened fitting.
7. To purge any remaining gas out of the system, the Priming Bleed function can be used.
8. With all fittings tightened, return to the main screen and enter the maximum setpoint allowable by the primary range of the CPC8000-H or the DUT's maximum range, whichever is lower and confirm the CPC8000-H can control to the maximum pressure.
9. If the controller fails to reach the maximum pressure, there may be a leak or more trapped air in the system.
10. Repeat Steps 2-8 if you suspect more air is trapped in the system

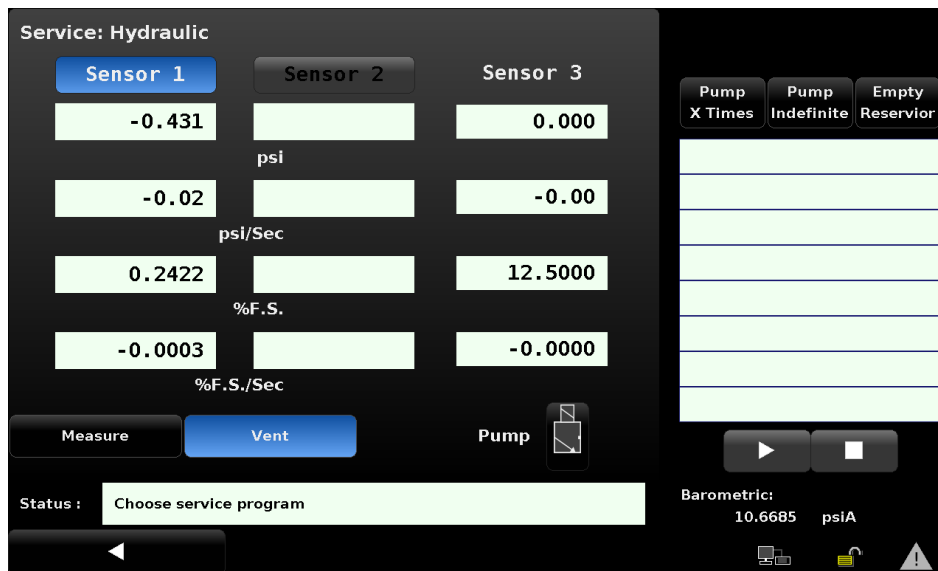

Figure 5.2.4 Hydraulic Service App

EN

6. Operation

6.1 General Operation

This section describes the procedures for operating the CPC8000-H from the front panel. Instructions for operating the device remotely from an external computer are covered in Section 7, Remote Operations. By following the procedures provided in these two sections and Section 8.2, Recalibration, you can expect your CPC8000-H to deliver maximum accuracy and dependability for many years of useful service.

EN

6.1.1 Power Up

Connect the included AC power cord into the power inlet on the rear of the instrument, and depress the power switch on the front of the instrument. The instrument will turn on and go through an initialization process and system check. As soon as the system check is completed, the system will default to a screen similar to the one shown in Section 6.1.3 Display Screen Features. The main screen may be configured in many different ways but initially it will be in a default configuration. Subsequently, the unit will power up in the configuration that it was in when last powered off.



WARNING!

Allow 60 minutes of warm up before performing critical pressure measurements.



WARNING!

Do not position the equipment so that it is difficult to remove the power cord. The instrument is not intended for connection of long-distance lines, i.e. lines within a building that are longer than 30 m, or that leave the building (including lines of outdoor installations).

6. Operation

6.1.2 Setup Applications

Configuration of the CPC8000-H is achieved by changing settings accessed through the Application (“App”) buttons. Local operation is accomplished by observing the data presented in the display. The appearance and functionality of the display can be changed by pressing the App button for the related function. After an App has been chosen, a set of related parameters will appear on the left. After choosing one of these parameters, a set of selections related to that parameter will appear on the right or a data entry keypad. The desired selection or data can be entered here.

EN

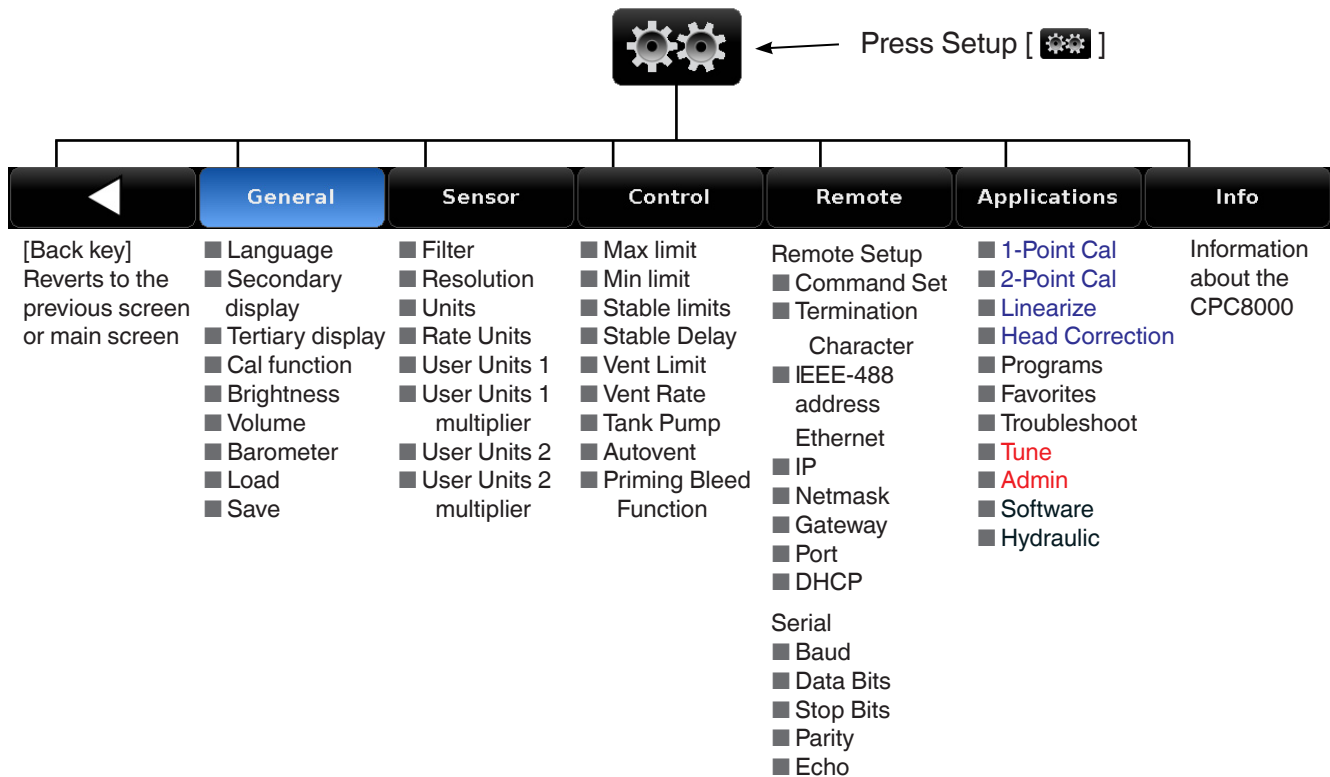

Figure 6.1.2 - Menu Tree of the Setup Menus

6. Operation

6.1.3 Display Screen Features

The screen shown below provides an overview of the features that may appear on the display after initialization. The left two thirds of the display contains the area where information is displayed (in this case the Home Application) and the right one third contains the selection icons for each application. A tare button, zero button, bar graph and up to two of the available auxiliary displays (Peak, Rate, Sensor 3, Units, Tare, Uncertainty) will appear in the Home App, if activated. All of the CPC8000-H screen features are described in more detail throughout this manual. Any button activated will turn a different shade of blue.

EN

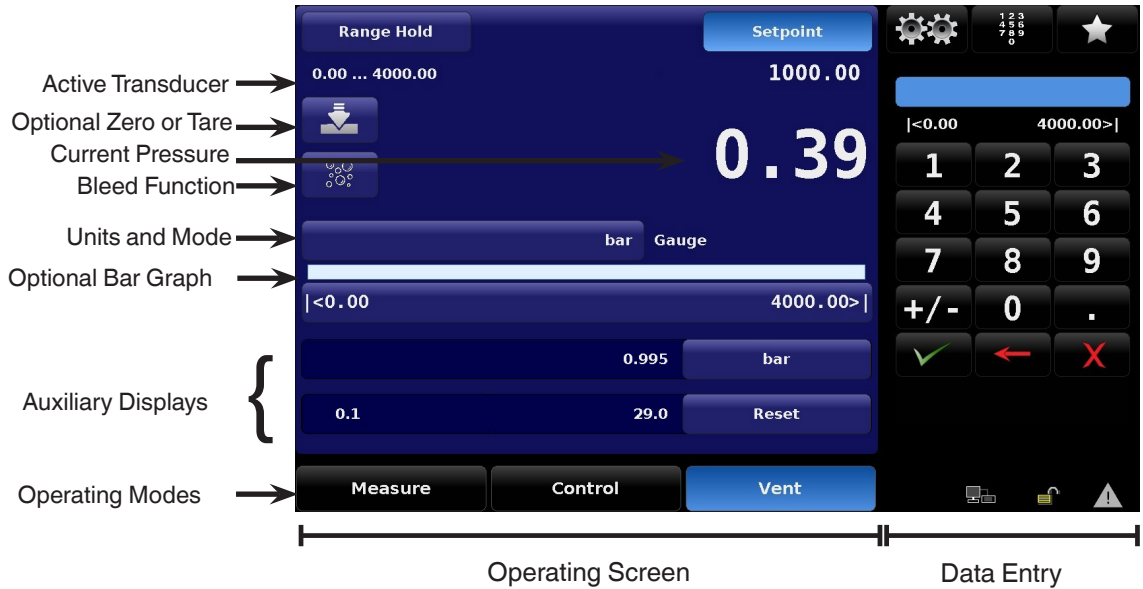



Figure 6.1.3 Display

6.2 Initial Setup

Section 6.2.1 and 6.2.2 are provided first so that the operator can initially check the information screen to verify the installed components and to change the language if needed.

6. Operation

6.2.1 Information Application

Select the  Settings application on the top right of the screen and navigate to the information application. The information tab will contain the Mensor contact, installed transducers, installed regulator along with instrument and software version information.

EN



Figure 6.2.1 Information Screen

6.2.2 Language Selection





Pressing the  Settings button and navigating to the General tab, will display the options for Language, Secondary Display, Tertiary Display, Cal Function, Brightness, Volume, Barometer (optional), Load and Save. The language selections available are shown in the column on the right and the active language will be highlighted blue.



Figure 6.2.2 Language Selection

6.3 Application Selection and Parameter Inputs

The data entry section on the right third of the screen (see figure 6.1.3 Display Screen Features) is the area where  Settings,  Setpoints or  Favorites can be chosen. The Settings App is used to navigate away from the main screen and configure the instrument. The Setpoints App is used to display various keypads, and the Favorites App is used to select favorited programs.

6. Operation

6.4 Applications

6.4.1 Main Screen

The main screen is the normal operation screen. This application is used to monitor and control pressure, run sequences, select ranges, select units, observe auxiliary values, choose setpoints, and optionally emulate pressure types. Figure 6.4.1-A shows the basic main screen. Figure 6.4.1-B shows the main screen with auxiliary and autozero options enabled. Figure 6.4.1-C shows the main screen with the units button selected.

EN



Figure 6.4.1-A Main Screen



Figure 6.4.1-B Main Screen w/Auxiliary



Figure 6.4.1-C Main Screen Units

6.4.1.1 Range Hold

The Range Hold button allows the user to select the active range transducer from a list of installed transducers. By clicking Range Hold, the user can select the active transducer from the primary and optional secondary transducer. The instrument must be fully vented in order to switch between ranges. The primary range will always be listed on top and the secondary range will be beneath.

6. Operation

EN

Range Hold



Figure 6.4.1.1 Range Hold

6.4.1.2 Setpoint

By default, the Setpoint application has the numeric keypad enabled. Using the keypad within the Setpoint application allows the user to enter the desired pressure value within the range of the transducers and module inside the instrument. There are multiple ways of entering the control setpoint: numeric keypad, number pad step, percentage step, digit step or a program. These methods can be accessed by pressing the keypad button on the top right of the screen (Figure 6.4.1.2-A)



Figure 6.4.1.2 Setpoint

6.4.1.2.1 Numeric Pad

The default entry method provides 10 digits for numeric entry, plus the decimal point and sign key (Figure 6.4.1.3). Each key that is pressed will display in the blue text box directly above the keypad. The sign key **+/-** will allow the user to toggle between positive and negative values. This key can be selected at any point while entering a number. Once the desired value is entered in the blue text box, the check button **✓** can be pressed to change the setpoint to this value. If the value is outside of the setpoint minimum or maximum limits, directly beneath the blue text box, the numbers will turn red and the setpoint change will not be accepted. To clear an entry, select the cancel button **✗** and the blue text box will be reset. The backspace button **←** is used to clear the last character that was entered.

PN 0018708001J 03 / 2024 EN

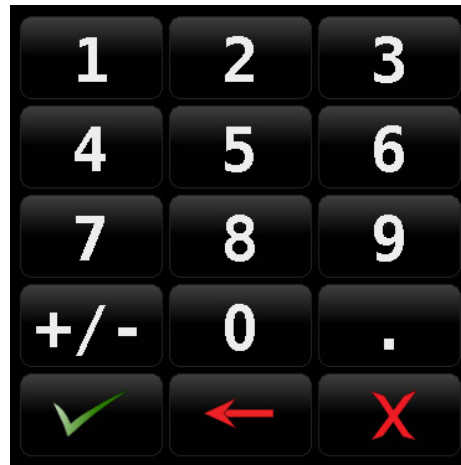

Figure 6.4.1.3 Keypad

6.4.1.2.2 Number Pad Step

The number pad step method provides the same keys as the numeric keypad and also includes up and down buttons for quick and easy setpoint changes. The number between the two arrows shows the value that will be added or subtracted from the current setpoint when an arrow is pressed. The Up ▲ button increases and the Down ▼ button decreases the current setpoint by the digital step value. The digital step value can be changed by entering a number using the numeric keypad and selecting either the Up or Down button. The setpoint in Figure 6.4.1.4 will change by 14.5 psi each time the Up or Down button is pressed. v



Figure 6.4.1.4 Number Pad

6.4.1.2.3 Percent Step

The Percent Step entry method allows the user to select setpoints based on a percentage of the primary transducer installed. Pressing the transducer range button at the top will open the Step Settings application (Figure 6.4.1.4.1-B). In this application, the user can select between 2 to 12 preset steps in percentages or pressure values, overrange percent, and minimum and maximum DUT limits. Users can also customize the setpoints by selecting the individual tiles and typing in the desired setpoints. Simply press the transducer range button on the top right to go back to the home screen. From here, press the specific percentage or pressure value and the setpoint will immediately change to the chosen setpoint. The up and down arrows at the bottom right of the screen allow for nudging the pressure reading by the increments displayed to the right. These increments can be changed using the Digital Step application.

PN 0018708001J 03 / 2024 EN

6. Operation

EN



Figure 6.4.1.5-A Percent Step



Figure 6.4.1.5-B Step Settings



6.4.1.2.4 Digit Step

The Digital Step entry method allows the user to step the setpoint up or down by increments of 1 in the selected position. For example, in the picture below the 1 is in the tenths position, so it will step up to 10,000.1 or down to 9,999.9 upon pressing the corresponding arrow key. The user can change the placement of the 1 by pressing the desired position signified by a white 0. There can only be one digit representing a 1 at a time.







Figure 6.4.1.2.4 Digit Step

6.4.1.2.5 Programs

The Programs entry method provides an automated way to interact with the CPC8000-H. Many settings or processes that can be entered manually can be programmed into the unit and saved and used in the Program portion of the keypad entry screen. Programs can be created, edited, deleted and saved in the Program  application located under the Settings , then Applications>Programs. The example program (Figure 6.4.1.4.3) shows the selection of program named "Zero" and the sequence

6. Operation

it will start when the play  button is pressed. The play  button can be pressed again to pause the program at any step. The Up  and Down  arrows can be pressed to skip or go back to a sequence step.

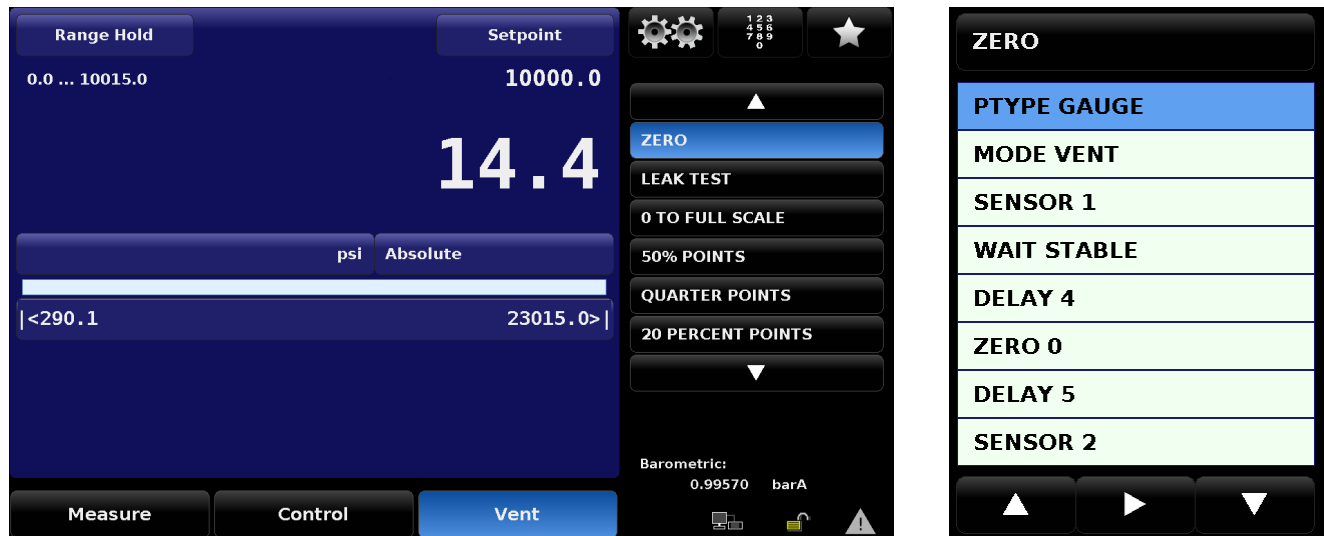

Figure 6.4.1.2.5 Programs

6.4.1.3 Favorites



The Favorites  application provides access to up to 8 sequences. Unlike the Programs application, the Favorites does not have a scroll wheel to cycle through all programs available. This application is primarily for programs that are frequently used. The displayed programs can be set/saved in the Favorites  application, which is accessed by selecting the Settings  button then Applications>Favorites.



Figure 6.4.1.3 Favorites

6.4.1.4 Units and Pressure Type

The Units button is always displayed. When the Units button is pressed, a selection of imperial and metric units will be displayed on

6. Operation

EN

the right. Here, the user can select which active units will be used when displaying the pressure reading on the main screen. The Pressure Type button is a label indicating the native mode of the transducers being used (absolute or gauge). When an optional barometer is installed, the button becomes selectable and allows the user to emulate the non-native pressure type. A native absolute transducer will subtract the barometric reading to emulate a gauge reading, alternatively, a native gauge transducer will add the barometric reading to emulate absolute pressure. Pressing this button will toggle between native and non-native modes.

Pressure Units button

Pressure Type button

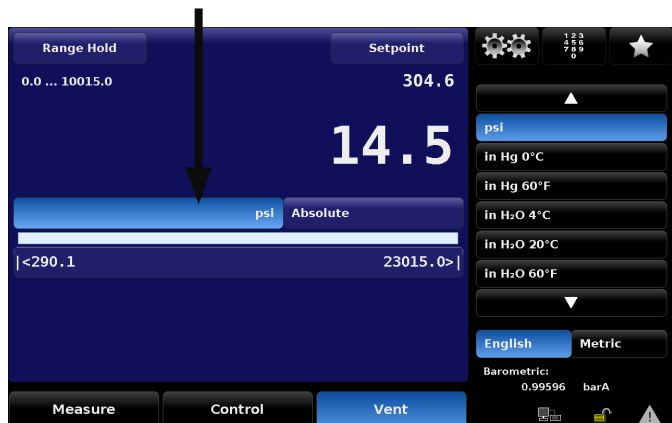

Figure 6.4.1.4 - A Pressure Units

Figure 6.4.1.4 - B Pressure Type

6.4.1.5 Bar Graph and Control Limits

The Bar Graph is always active on the main screen and it displays the real time pressure on the Measure/Control port. It is displayed in the form of a blue bar that spans left to right to provide a visual comparison between the actual pressure and the control limits. When completely vented, the screen will display a blank white bar as seen below. Control limits are the minimum and maximum limits that are entered under Settings > Control (See Section 6.4.2.3.1). These limits will default to the maximum primary range of the instrument, but can be adjusted to any desired limit within the transducer range. These limits will also limit the value that can be entered as a setpoint. If a value outside this limit is entered, the instrument will display the value in red.



Figure 6.4.1.5 Bar Graph/Limits

6. Operation

6.4.1.6 Auxiliary Displays

There are two spaces on the screen reserved for auxiliary displays. These two positions are titled Secondary Display and Tertiary Display under the Settings > General application. Figure 6.4.1.8 shows the position of each of these options. In this example, the Secondary Display is set to units "bar" and the Tertiary Display is set to peak. Each display can be chosen independently and configured to show none, both or just one on the Main screen.



Figure 6.4.1.6 Auxillary Displays

6.4.1.7 Operating Modes

The CPC8000-H has three operating modes: Measure, Control, and Vent. After the system has been switched on and the bootup sequence has run, the instrument will automatically be placed in Measure mode. The operator can switch from one mode to another by using the mode selection keys located on the bottom row of the Main screen. The active mode will be highlighted blue. Figure 6.4.1.9 shows Vent mode as the active mode.



Figure 6.4.1.7 Operating Modes

6.4.1.7.1 Measure Mode

The Measure mode is activated by pressing the Measure button on the bottom left of the screen. When selected, it will be highlighted blue (Figure 6.4.1.9.1). In Measure mode the CPC8000-H acts like a precision pressure measuring instrument or indicator, and displays the pressure applied at the Measure/Control DUT port. This mode turns off all regulator control and puts the system in a static state. This allows the pressure to remain held at a specific setpoint or reading without any fluctuations caused by

6. Operation

the controller. If the pressure raises to 4% over the max range, the reading will turn red.



Figure 6.4.1.7.1-A Measure Mode

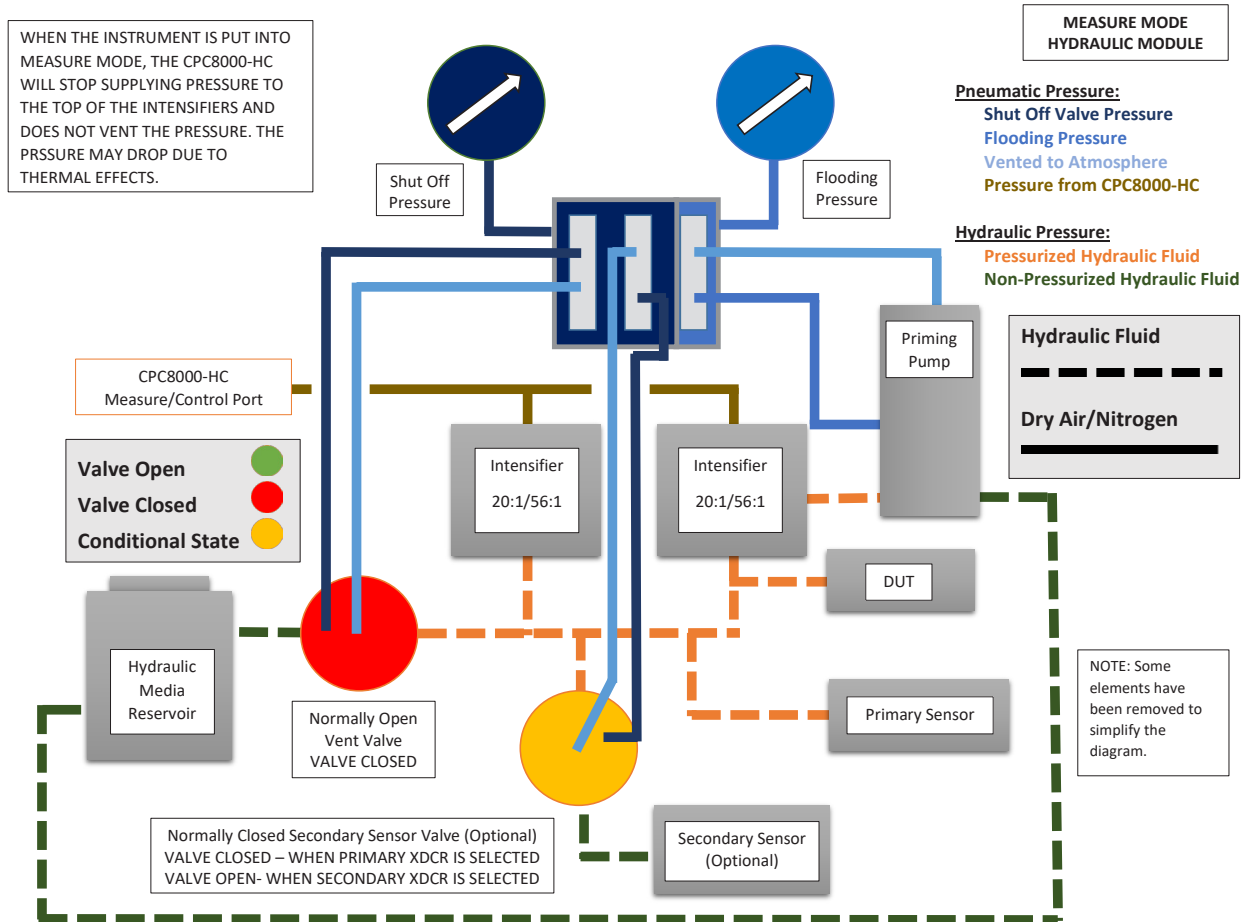

Figure 6.4.1.7.1-B Isolation Valves in Measure Mode

6.4.1.7.2 Control Mode

Control mode is activated by pressing the Control button in the bottom center of the screen. When selected, it will become highlighted blue (Figure 6.4.1.9.2-A). When in control mode, the CPC8000-H acts as a precision pressure controller and delivers pressure to the Measure/Control DUT port. When this mode is initiated from Vent (Figure 6.4.1.9.2-B), the instrument will activate the priming pump in the hydraulic module. If the Priming Bleed function is enabled, the bleeding sequence will begin. Otherwise, the instrument will attempt to prime to a minimum starting pressure. The system typically takes 3-4 priming cycles to achieve the minimum pressure. By default, the instrument will attempt a maximum of 10 priming cycles. The maximum number of prime cycles can be changed within the Settings > Control parameters. If the instrument fails to achieve the priming pressure, the instrument will vent. Check the DUT for leaks and try again. Once this priming sequence is successfully completed, the instrument will stay in control mode and go to the setpoint. When the reading gets to the setpoint and satisfies the requirements of the stability window, the reading will change from white to green. By default, the limits of control mode are based on the primary sensor range.

WARNING!

Never pressurize the instrument over the test sample range.

Overpressuring the connected test sample can lead to damage or bursting of the device under test. This can cause personnel and property damage.



6. Operation



Figure 6.4.1.7.2-A Control Mode

EN



Figure 6.4.1.7.2-B Control Mode

6. Operation

EN

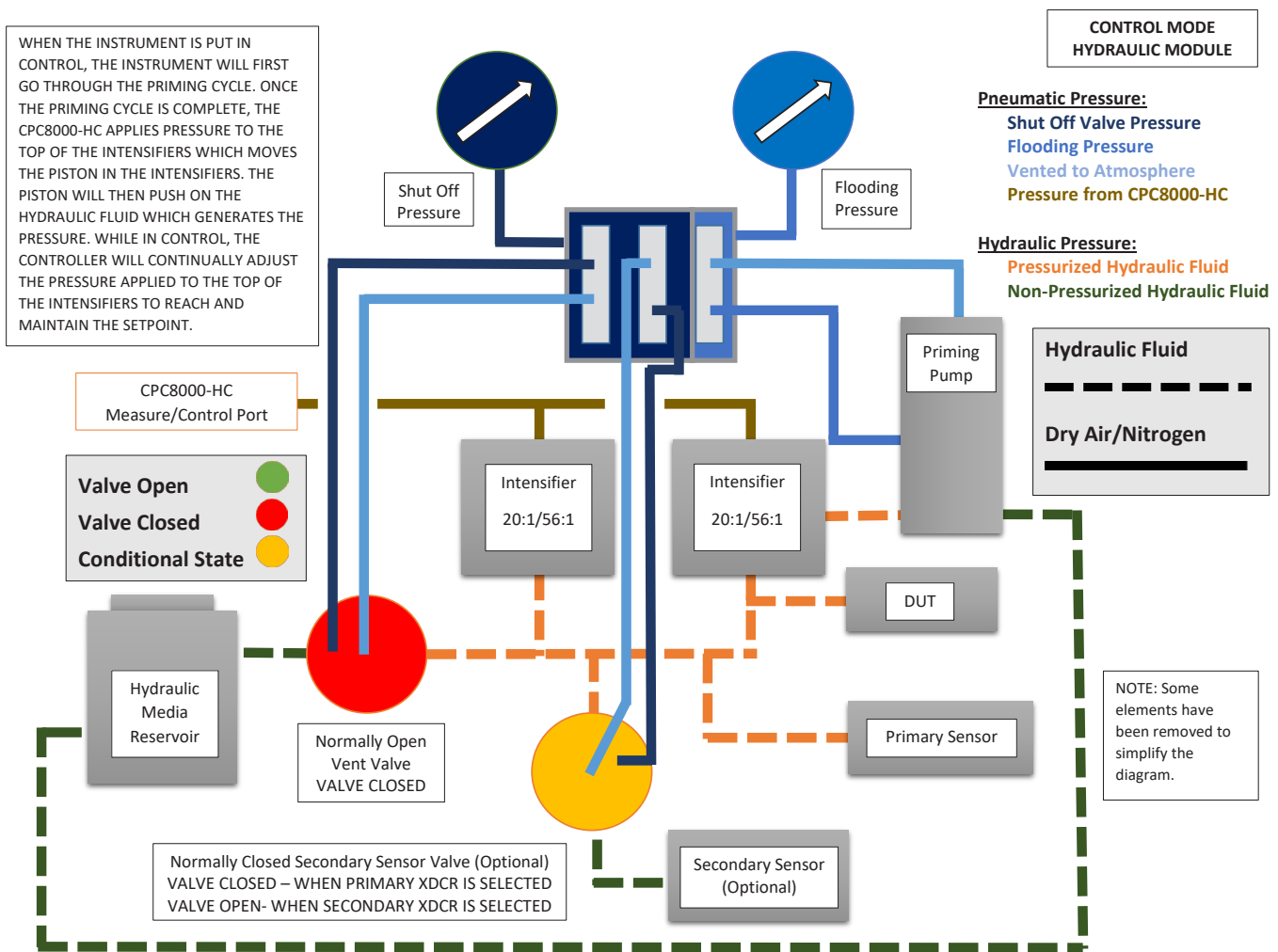

Figure 6.4.1.7.2 - C Isolation Valves in Control Mode

6.4.1.7.3 Vent Mode

The Vent mode is activated by pressing the Vent button on the bottom right of the screen. When selected, it will become highlighted blue (Figure 6.4.1.9.3). During Vent mode, the CPC8000-H will relieve all pneumatic and hydraulic pressure that is on the system. The pneumatic pressure will be evacuated through the Vent port on the CPC8000-HC and the hydraulic pressure will be released into the media reservoir located within the CPC8000-H.



Figure 6.4.1.7.3 - A Vent Mode

6. Operation

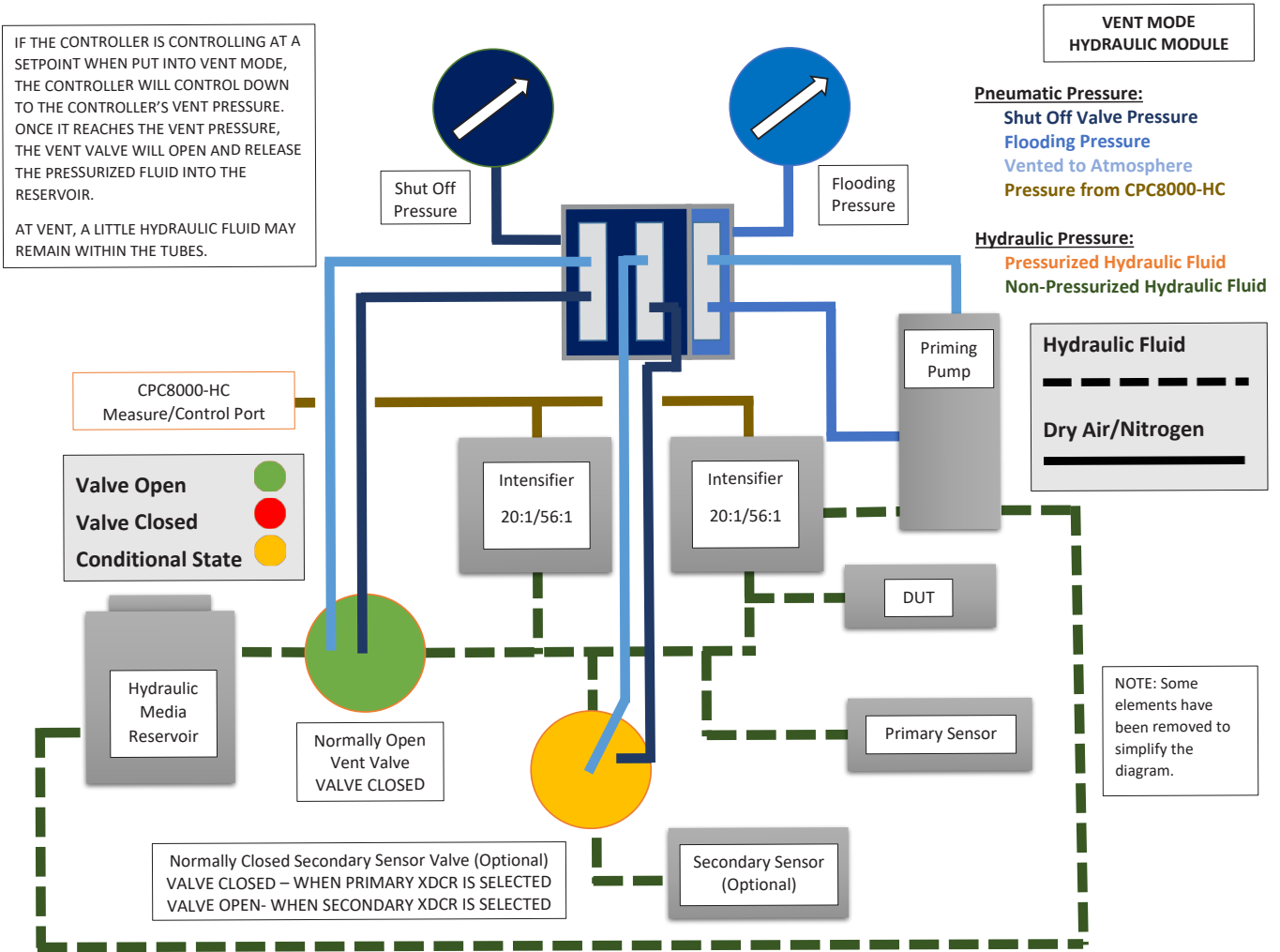

Figure 6.4.1.7.2 - B Isolation Valves in Vent Mode

6.4.1.8 Status Bar and Barometer Reading

The Status bar (Fig. 6.4.1.10) is located at the bottom right of the screen. This area will display your remote connectivity , touchscreen lock/unlocked , and the error flag , as well as the optional barometric reference reading. The remote connectivity icon will be highlighted green if a remote connection is active. This connection can be made using an IEEE-488, RS-232, Ethernet or USB connection. The settings for these interfaces can be found in section 6.4.2.4 Remote Settings. The touchscreen lock icon will switch to the locked position if the touchscreen lock is enabled. This can be enabled using a remote command found in the Remote Commands section. The error flag will be highlighted yellow if there is an active instrument error or a remote command is invalid. A detailed explanation of the error flag can be found in the Trouble Shooting application section. Directly above the status icons will be the optional barometric reference reading.

This device is plumbed to the rear port of the instrument and displays the local atmospheric pressure. The units for this pressure reading can be changed in the settings application under barometer units.



Figure 6.4.1.8 Status Bar

6.4.2 Settings

The Settings application can be accessed by selecting the gears icon  located on the top right of the Main screen. This application gives access to all general, sensor, remote, control, applications and information settings and menus. The settings application provides the user with many customizable options that can be easily accessed. Most of these settings can be saved to configuration files in order to make easy transitions between the instrument and different customer applications. Figure 6.4.2 shows how the Settings application is accessed.

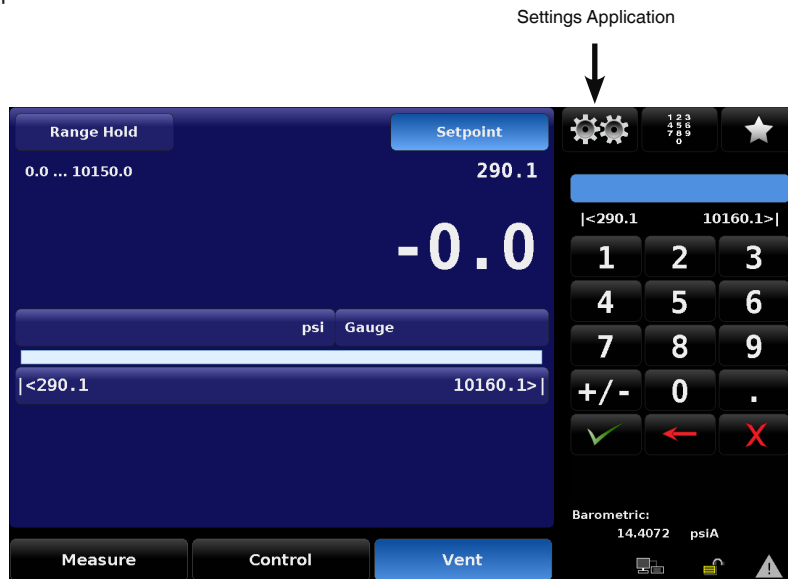

Figure 6.4.2 Settings Application

6.4.2.1 General Settings

The general settings screen options allows the user to change the language, auxiliary displays, main screen calibration functions, brightness, volume, optional barometer units, and loading/saving configurations. All of these settings will change the way the main screen of the instrument is configured. By default, the general application will always start with the Language options selected (Figure 6.4.2.1).



Figure 6.4.2.1 General Settings

6.4.2.1.1 Languages

The Language settings (Figure 6.4.2.1) provides a selection of different languages. Once a language is chosen, all words within all menus will appear in the chosen language and the radix character (decimal mark), will change from a dot (.) to a comma (,) depending on the language chosen. The highlighted language will remain the default language until another language is chosen.

6.4.2.1.2 Auxiliary Displays

The CPC8000-H homescreen has 2 available slots for additional auxiliary displays. These two displays can be chosen on the General settings application by selecting "Secondary Display" or "Tertiary Display". Each of these options can be configured to show the peak, rate, sensor 3 (pilot sensor), units, tare, or uncertainty.

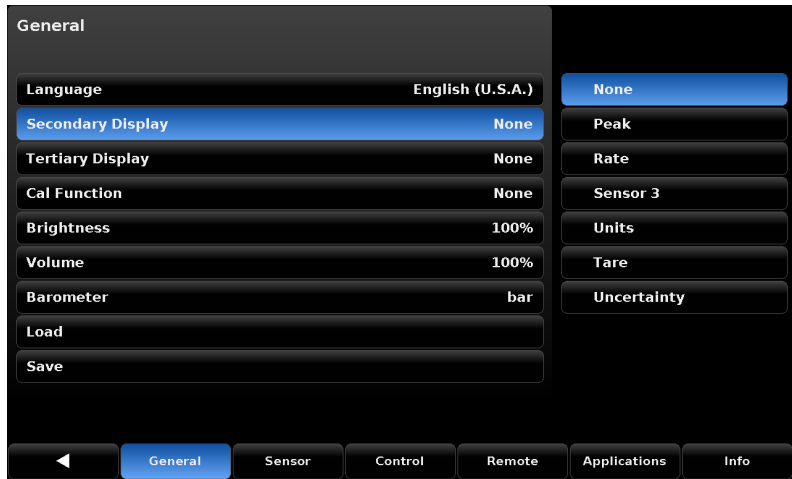

Figure 6.4.2.1.2 Auxiliary Displays

Some of these auxiliary displays can be modified on the main screen by pressing the button that displays the secondary or tertiary display. Others simply display auxiliary information.

- **Peak:** This will display the upper and lower points that have been measured by the instrument. These values can be reset by pressing the reset button on the main screen
- **Rate:** The rate display will show the changing rate of pressure in the current units. The time factor will be per second or per minute and this can be chosen on the main screen in the auxiliary display section.
- **Sensor 3:** This option will display the pilot sensor (pneumatic pressure) in the current pressure units.
- **Units:** The units display will provide a second set of pressure units to be visible on the home screen. The units can be selected and changed on the main screen by pressing the units auxiliary button.
- **Tare:** The tare display will show the offset/tare value if it is activated.
- **Uncertainty:** This will show the accuracy of the pressure being displayed.

6. Operation

6.4.2.1.3 Cal Function

The Cal Function provides the option of choosing Zero or Tare to be displayed on the main screen. Only one of the two can be chosen at a time.

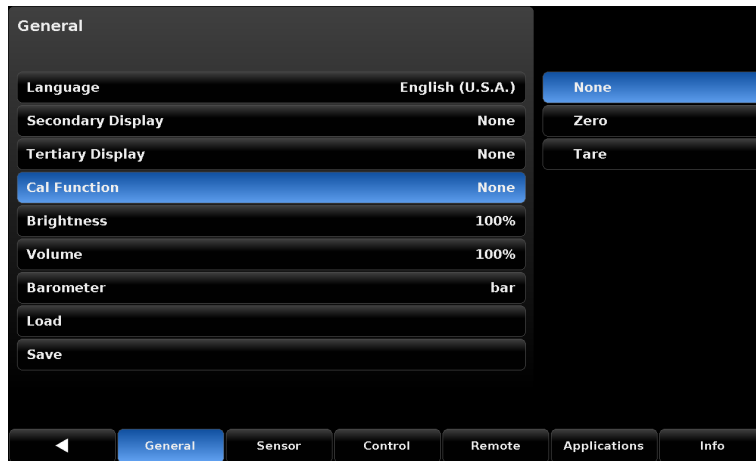



Figure 6.4.2.1.3 A Cal Functions

• Zero Function

When the zero option is chosen, it will become displayed on the upper left side of the main screen (Figure 6.4.2.1.3-A). The zero function allows the active transducer to perform a zero point calibration from the home screen. This operation will be permanently saved to the transducer memory if the instrument is in the native pressure units. It will temporarily save a zero offset if the instrument is being emulated. The emulated zero and native mode zero are independent of each other, so a zero routine will need to be performed on each pressure type, if desired. During the zeroing process, the touchscreen will be locked  and the sequence text will appear on the right side of the screen that lets the user know the process is ongoing. Although the screen is locked, the red  can still be pressed to cancel the process and unlock the screen.

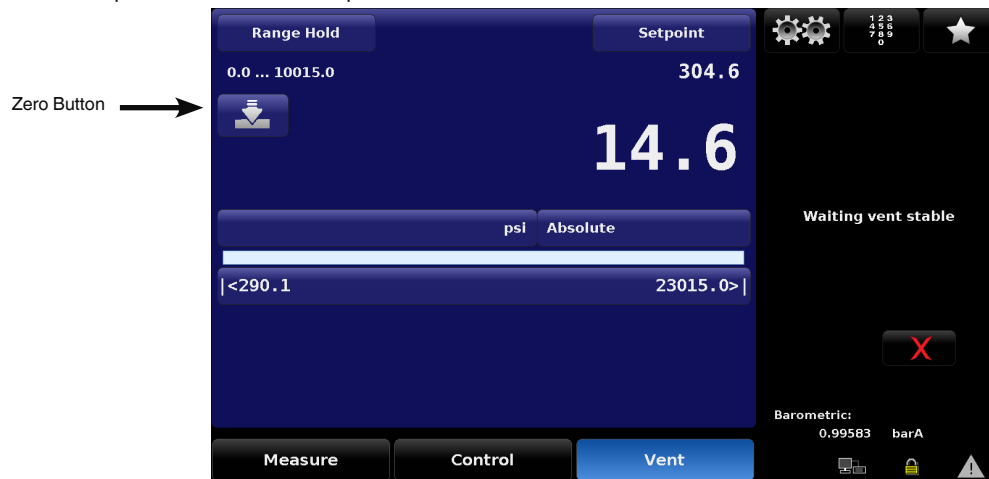



Figure 6.4.2.1.3-B Zero Button

• Tare Function

When the tare option is chosen, it will become displayed on the upper left side of the main screen (Figure 6.4.2.1.3-B). The tare function allows a tare offset to be applied to the sensor reading. When selected, the tare button will be highlighted yellow , the reading will go to zero and the setpoint will be adjusted by the tare value (Figure 6.4.2.1.3-C). This is a temporary offset and it will

6. Operation

be removed on reboot, when the tare function is removed, or when the tare button is pressed again.

Tare Button



Figure 6.4.2.1.3-C Tare Button



Figure 6.4.2.1.3-D Tare ON

6.4.2.1.4 Brightness

The Brightness settings can be adjusted by selecting the "Brightness" button and pressing a location on the green bar graph on the right side of the screen (Figure 6.4.2.1.4). This can be adjusted from 10% at the bottom point, up to 100% at the top. This adjustment will be implemented on all screens and can be saved to configurations. By default, the brightness is set to 100%.

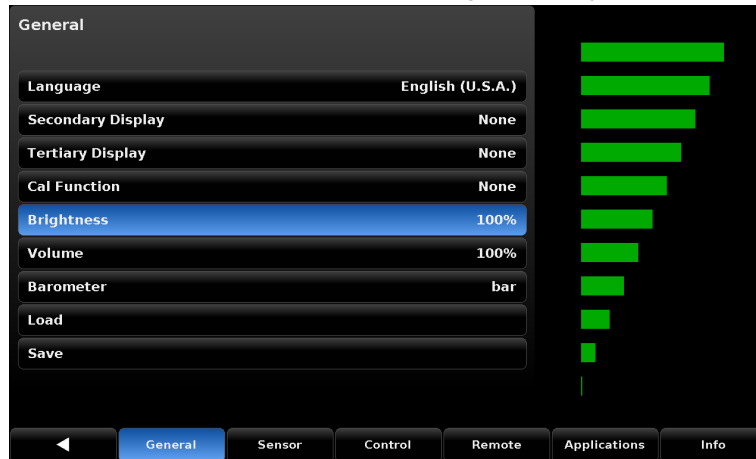

Figure 6.4.2.1.4 Brightness

6.4.2.1.5 Volume

The volume settings can be adjusted by selecting the "Volume" button and pressing a location on the green bar graph on the right side of the screen (Figure 6.4.2.1.5). This can be adjusted from 0% to 100% and the volume setting can be saved to a configuration. By default, the volume is set to 100%

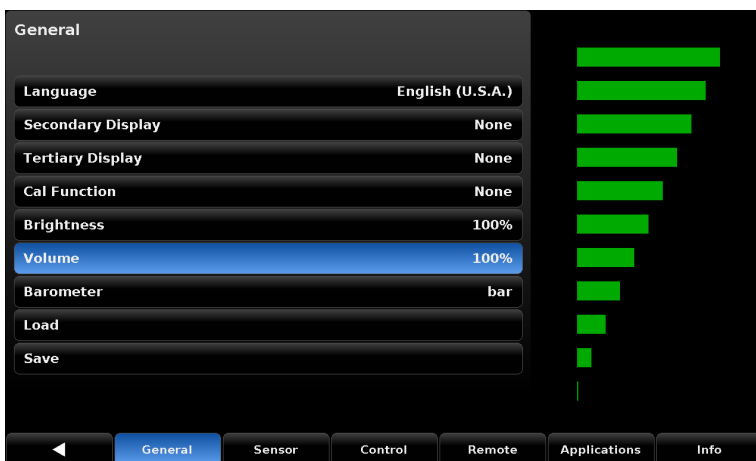

Figure 6.4.2.1.5 Volume

6.4.2.1.6 Barometer

The barometer units are selected on the general tab by pressing "Barometer" and then selecting the units on the right side of the screen (Figure 6.4.2.1.6). The barometer units are available in all the standard pressure units and can be in metric or english units. The chosen units will appear next to the barometric reference pressure reading located on the status bar in the bottom right corner of the main screen. The barometer selection will only appear if the optional barometric reference transducer is installed in the controller.

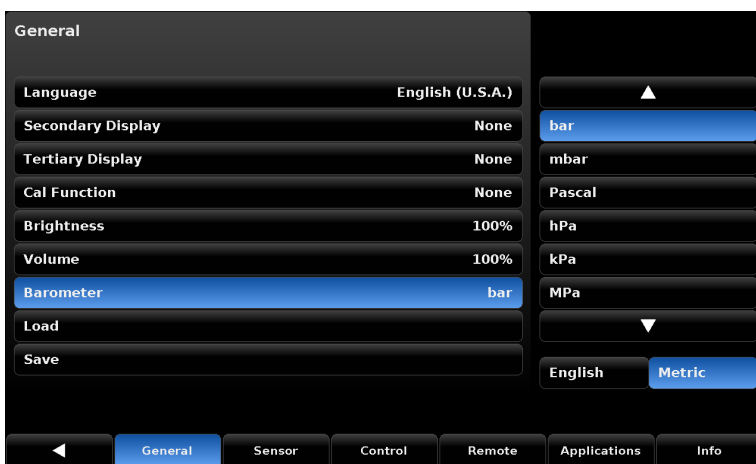

Figure 6.4.2.1.6 Barometer Units

6.4.2.1.7 Load/Save

The Load and Save buttons will give access to the configuration files that are used to save or load different instrument settings. When the Load button is selected, a list of 8 different configurations will appear on the right side of the screen (Figure 6.4.2.1.7-A). These configurations can be chosen by pressing the configuration button and selecting the button when prompted to load the selected configuration (Figure 6.4.2.1.7-B). To save the current settings to a configuration, select the Save button and then select a configuration and press the button (Figure 6.4.2.1.7-C).

6. Operation

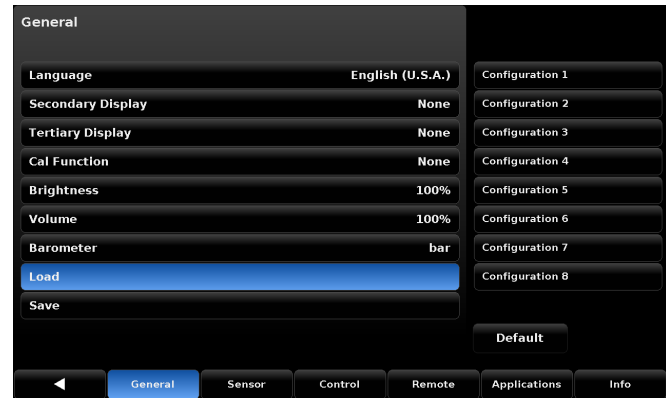

Figure 6.4.2.1.7-A Configurations

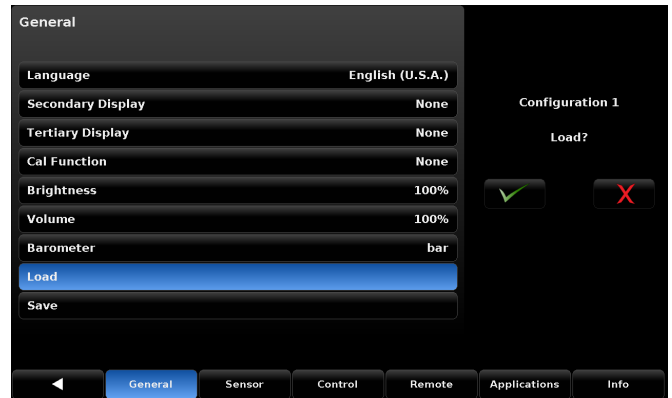

Figure 6.4.2.1.7-B Load Configurations

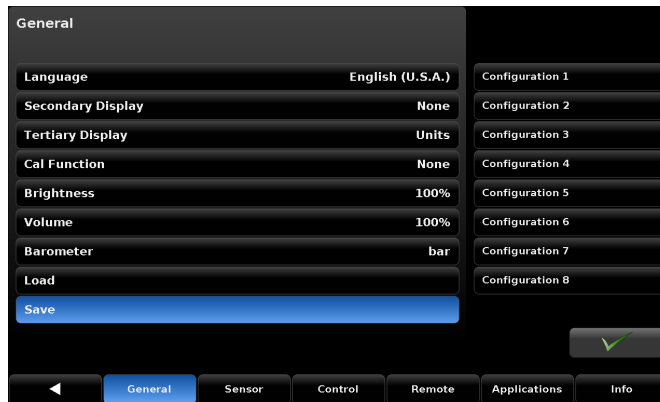

Figure 6.4.2.1.7-C Save Configurations

6.4.2.2 Sensor Settings

The Sensor settings can be accessed by entering the Settings  application from the Main screen and choosing the Sensor tab on the bottom row. This application allows adjustments to the filtering, resolution, units, rate units, and user units 1 and 2. All of these adjustments are applied as changes to the instrument software, they are not permanently stored on the sensor.

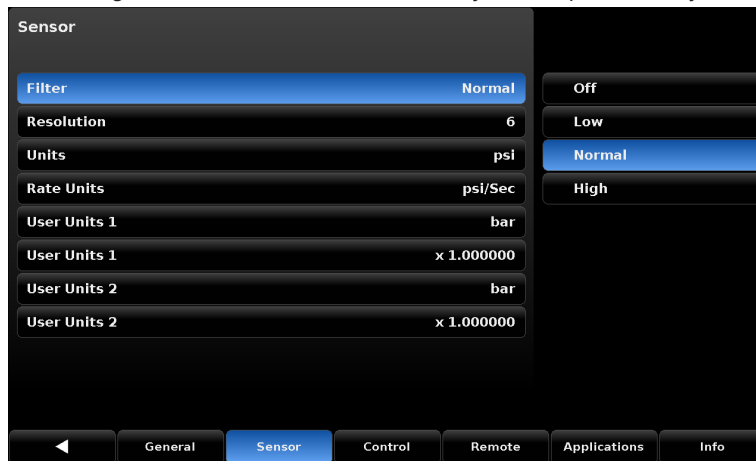

Figure 6.4.2.2 Sensor Settings

6.4.2.2.1 Filter

By default, the Sensor settings tab will open to the Filter setting menu (Figure 6.4.2.2). This setting applies a software filter to

6. Operation

smooth out the pressure readings. Because of differences in resolution, greater filtering may display a more stable reading for some pressure units. By default, the filter is set to "Normal", users can select varying degrees of filtering for the current units by selecting "Off", "Low", or "High".

EN 6.4.2.2.2 Resolution

The resolution of the displayed pressure value can be set in the Sensor settings using the Resolution button. The resolution allows the user to select between 4 and 6 digits of resolution on the sensor reading on the main screen. If a quartz (Paro) transducer is installed, then an option for 7 digits of resolution will be available to select.

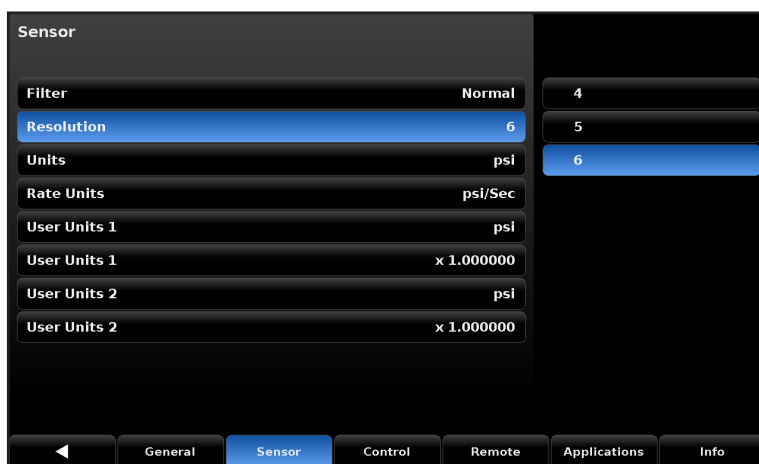

Figure 6.4.2.2.2 Resolution

6.4.2.2.3 Units

The pressure units setting can be found in the Sensor setting application by pressing the "Units" button (Figure 6.4.2.2.3). Pressing this will open a scrolling menu on the right side of the screen that allows the user to select pressure units in English or Metric systems. Selecting any of these units will change the unit of measure for all of the internal pressure transducers and will also apply these units to readings taken remotely. This setting is identical to the Units button on the Main screen.



Figure 6.4.2.2.3 Units

6.4.2.2.4 User Units and Multiplier Settings

The User unit settings can be found in the Sensor settings application by pressing the "User Units" button (Figure 6.4.2.2.4-A). These units are used to setup the "base unit" and along with a multiplier used to define User Unit 1 and User Unit 2. For each of these units, the same process can be followed. Selecting the first User Units 1 button will display choices of psi, bar, or pascal in the side bar. Choosing one of these "base units" will form the basis of the equation that defines the User Unit chosen. Immediately

6. Operation

EN

below the first User Units button is the User Units multiplier button that indicates the current multiplier and when pressed will display a keypad in the side bar where a new multiplier can be entered. These two choices are used to calculate the value of the User Units by following the equation: $\text{User Unit} = 1 \text{ (base unit)} \times \text{Multiplier}$. For example if a unit is needed, that is not currently available from the 40 choices, for instance tons per square meter (tsm), then the psi conversion factor for this can be found and is: $1 \text{ psi} = 0.703069 \text{ tsm}$. In this instance psi would be entered as the base unit and 0.703069 as the multiplier. The new user unit associated with this base unit and multiplier would now be displayed when that User Unit is chosen in the Main screen or on the Units selection above.

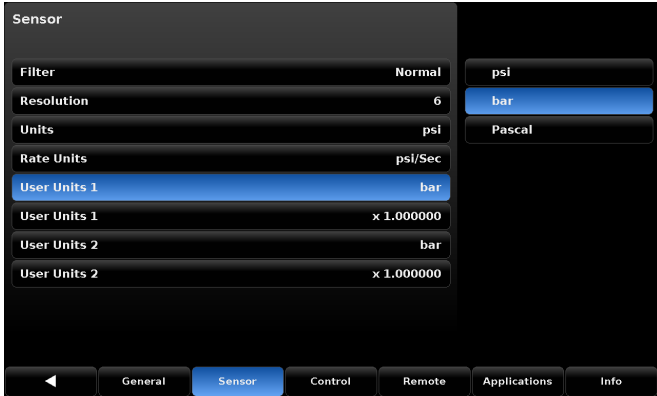

Figure 6.4.2.2.4-A User Units

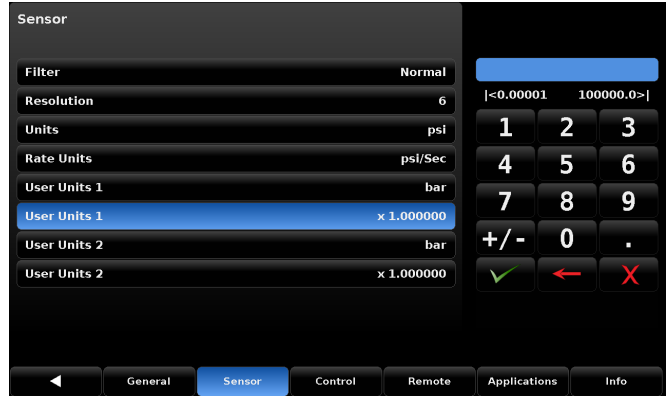



Figure 6.4.2.2.4-B Multiplier

6.4.2.3 Control Settings

The Control settings can be accessed by entering the Settings  application from the Main screen and choosing the Control tab on the bottom row (Figure 6.4.2.3). This application allows adjustments to the maximum and minimum control limits, stable limits, stable delay, vent limit, and tank pump.

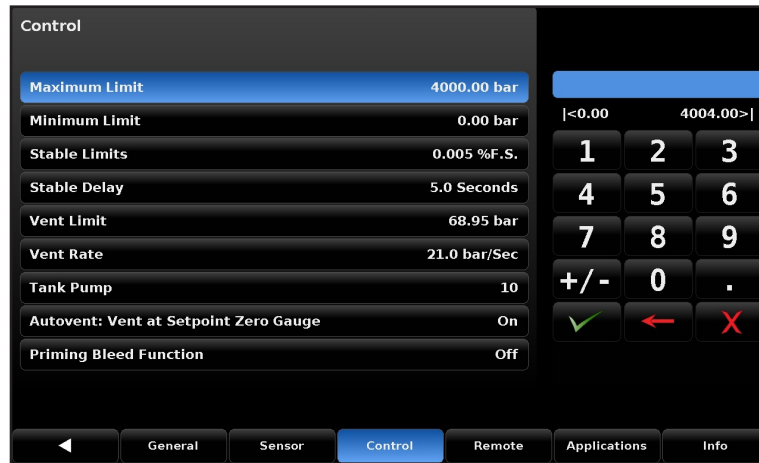

Figure 6.4.2.3 Control Settings

6.4.2.3.1 Maximum and Minimum Limits

The Maximum and Minimum Limits can be found in the Control application. By default, the Control application will have the Maximum Limit selected when first accessed (Figure 6.4.2.3). The Maximum/Minimum Limit will display a keypad on the right side of the screen that will be limited by a range directly beneath the blue entry box. The Maximum Limit must be greater than the Minimum Limit and less than or equal to the maximum sensor range. The Minimum Limit must be less than the Maximum Limit (Figure 6.4.2.3.1). If a number outside of the parameters is entered, the number will display red in the blue entry box and an error tone will occur. These entries provide a limit to the setpoint that can be chosen on the Main screen. This is often used to protect a DUT range that is smaller than the CPC8000-H range.

PN 0018708001J 03 / 2024 EN

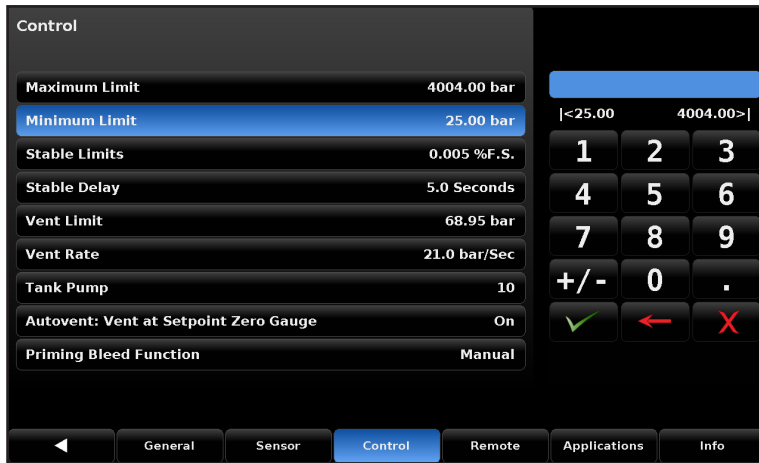

Figure 6.4.2.3.1 Minimum Limit

6.4.2.3.2 Stable Limits and Delay

The Stable Limits can be found in the Control application by pressing the "Stable Limits" button (Figure 6.4.2.3.2-A). The stable limit setting provides a tolerance window around the setpoint that will determine whether the instrument is stable. The default stable window is set to 0.005%FS. This number can be changed from zero to ten percent of the primary sensor range. The Stable Delay can also be found in the Control application by pressing the "Stable Delay" button (Figure 6.4.2.3.2-B). The stable delay is a period of time that the pressure output must remain within the stable limit window before the reading turns from white to green. This will also cause the remote stable flag to turn from "No" to "Yes". The Stable Delay units are seconds and can be set between 0 and 3600. For an example, the graph below (Figure 6.4.2.3.2-C) shows the Stable Limits set to 0.005%FS and the Stable Delay set to 5 seconds.

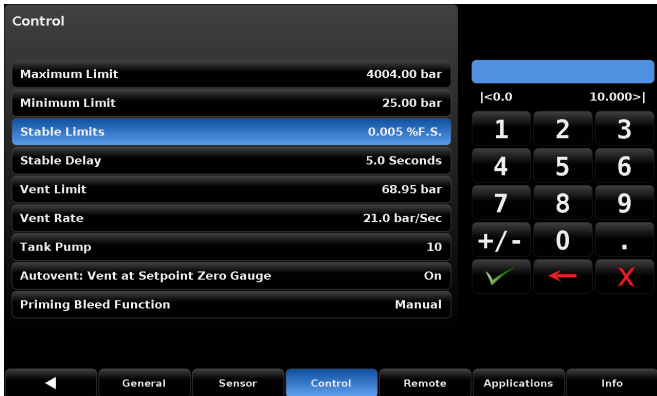

Figure 6.4.2.3.2-A Stable Limits

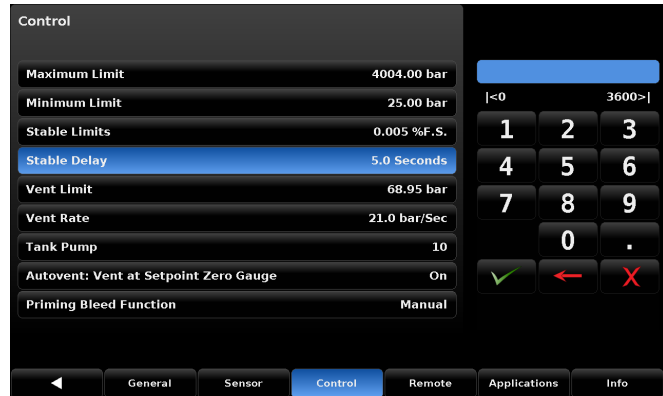

Figure 6.4.2.3.2-B Stable Delay

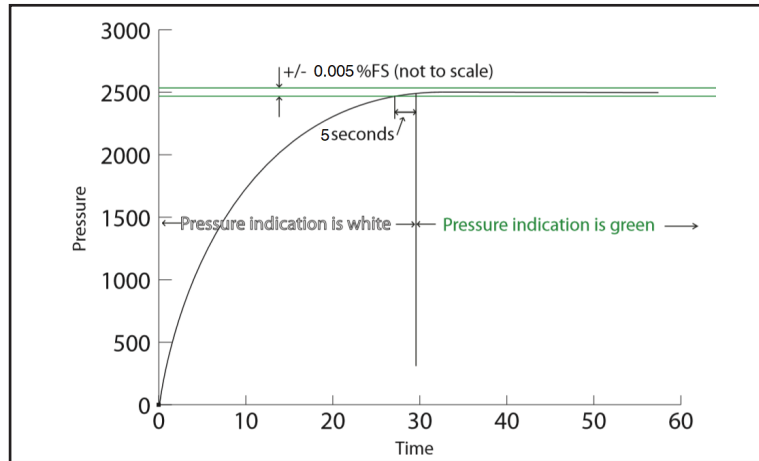

Figure 6.4.2.3.2-C Graph Illustration

6.4.2.3.3 Vent Limit

The Vent Limit can be found within the Control application by pressing "Vent Limit" (Figure 6.4.2.3.3). This is the pressure at which the controlled vent stops and the vent solenoid is opened, causing the pressure to vent through the vent port uncontrolled. The vent limit can be set within the values displayed under the blue box. At this pressure, the pneumatic pressure will be relieved through the vent port on the CPC8000-HC, and the hydraulic pressure will be released back to the media reservoir on the CPC8000-HM.



Figure 6.4.2.3.3 Vent Limit

6.4.2.3.4 Tank Pump

The Tank Pump setting can be found in the Control application and modified by pressing "Tank Pump" (Figure 6.4.2.3.4). The Tank Pump is the number of cycles that the priming process will attempt before failure. This process occurs when the instrument is switched from Vent mode to Control mode. The CPC8000-H will attempt to flood the system with hydraulic media to a threshold pressure. If this threshold pressure is not reached, it will cycle the priming pump again. This process will continue until the Tank Pump value has been reached. The Tank Pump has a default value of 10 cycles but can be set anywhere between 3 and 99.

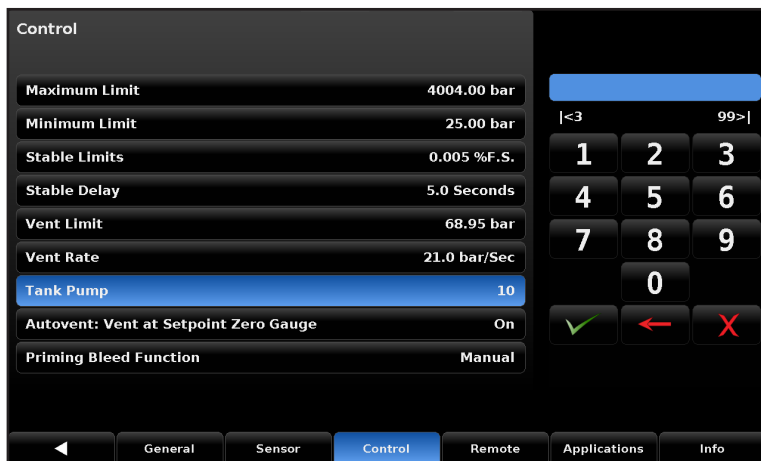
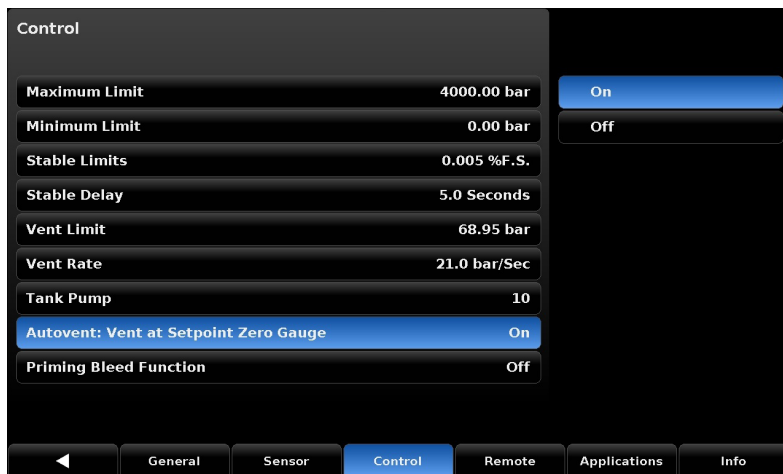

Figure 6.4.2.3.4 Tank Pump

6.4.2.3.5 Autovent

The Autovent option enabled, allows the user to enter 0.00 as a setpoint and the controller will Vent to atmosphere. During this time, the instrument will stay displayed and remotely in Control mode. Once a setpoint above atmosphere is entered, the system will engage the priming pump and start the standard control routine.

If this option is disabled, the controller will not allow a setpoint value less than the minimum priming pressure limit for the CPC8000-H version that is being used.



6.4.2.4 Remote Settings

The Remote settings can be accessed by entering the Settings  application from the Main screen and choosing the Remote tab on the bottom row (Figure 6.4.2.4). This application contains two pages and allows adjustments to the command set, termination character, and all settings related to IEEE-488, ethernet, and serial communication ports. This application is used when configuring a remote connection between the CPC8000-H and an external computer. Details about remote operations and commands can be found in Section 7.

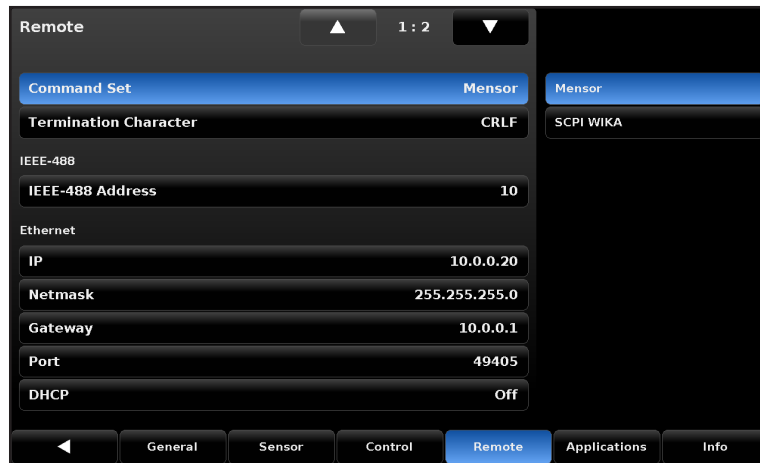

Figure 6.4.2.4 Remote Settings

6.4.2.4.1 Command Set

The Command Set button within the Remote application provides a place for the operator to choose which command set that will be used within remote communication software to control and query the CPC8000-H. When the Command Set button is selected, any of the listed command sets available will appear on the right side of the screen (Figure 6.4.2.4). The active command set will be highlighted blue, changing to a different command set will allow the CPC8000-H to automatically switch to the new communication format.

6.4.2.4.2 Termination Character

The Termination Character button within the Remote application provides an option for the user to select the desired termination character in the output string of the instrument (Figure 6.4.2.4.2). In most cases, this can be set to "default" where the instrument automatically chooses the termination character based on the selected command set. The options for termination characters are as follows:

- CRLF : Carriage Return Line Feed
- CR : Carriage Return
- LF : Line Feed
- EOI : End of Input

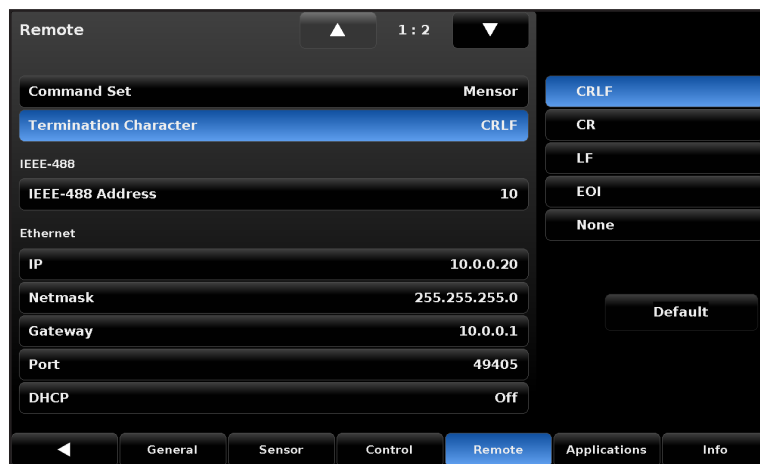

Figure 6.4.2.4.2 Termination Character

6.4.2.4.3 IEEE-488 Address

PN 0018708001J 03 / 2024 EN

6. Operation

The IEEE-488 Address button within the Remote application provides a place for the operator to set the IEEE-488 address (Figure 6.4.2.4.3). When this button is selected, a keypad will appear on the right side of the screen. The operator can input a value between 1 and 31 to change the address of the instrument.

EN

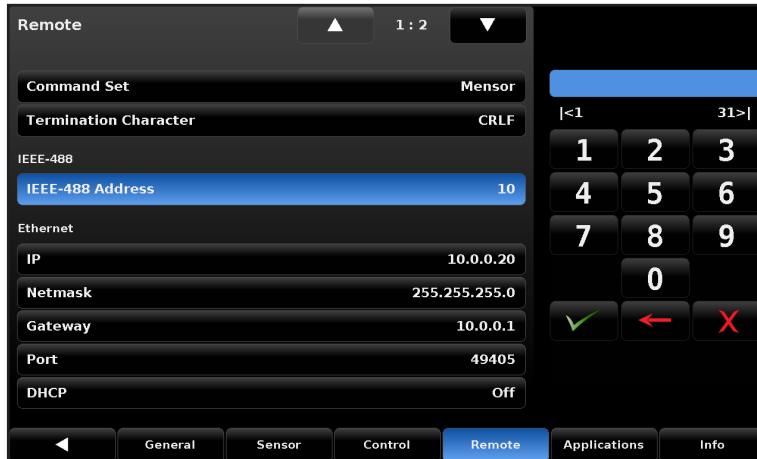

Figure 6.4.2.4.3 IEEE-488

6.4.2.4.4 Ethernet Settings

In the Ethernet section of the Remote application, there are buttons that correspond to Ethernet parameters. When a button is pressed, the numeric key pad or a choice selector will be displayed on the sidebar and an appropriate number or selection can be entered for the respective parameter. With DHCP turned off, a static IP address can be assigned. If DHCP is turned on and a lease is obtained successfully, the ethernet parameters are greyed and inactive but show the newly assigned lease. If a DHCP server fails to respond, DHCP will automatically turn off. Turning DHCP off allows the ethernet parameters to be edited and a static IP address assigned.

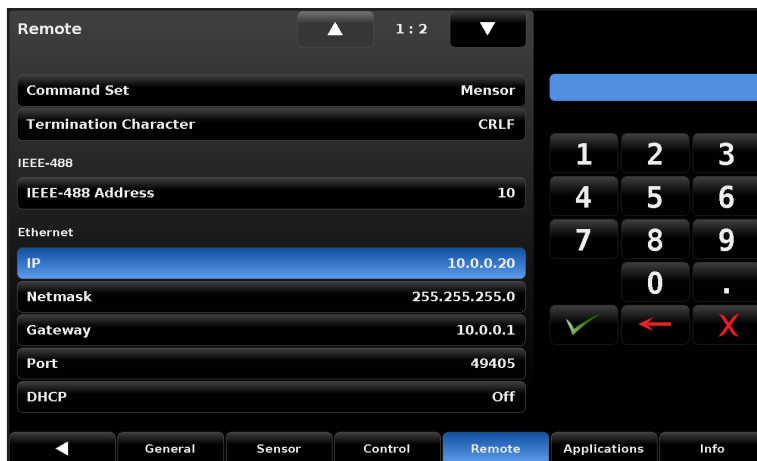



Figure 6.4.2.4.4 Ethernet Settings

6.4.2.4.5 Serial Settings

The Serial settings, within the Remote application, can be found on page two by pressing the down arrow  located at the top of the screen (Figure 6.4.2.4.5). The Serial setup page has buttons that correspond to serial communication parameters. When a parameter button is pressed, a choice selector will be displayed on the right side of the screen. The settings include baud rate, data bits, stop bits, parity and echo.

PN 0018708001J 03 / 2024 EN

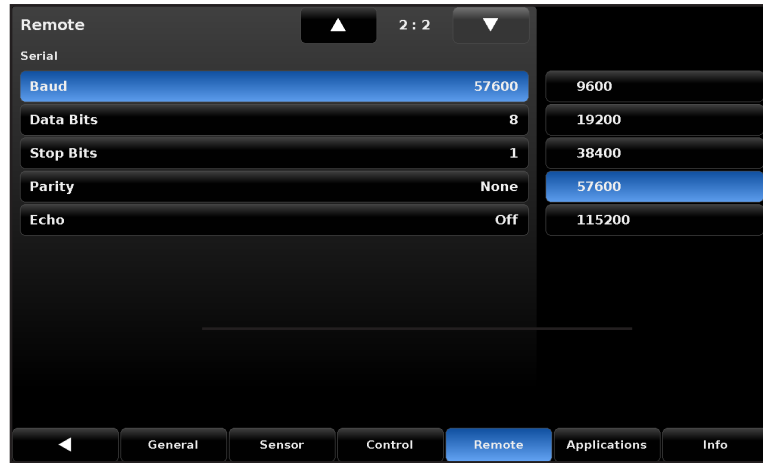



Figure 6.4.2.4.5 Serial Settings

6.4.2.5 Applications

The Applications settings can be accessed by entering the Settings  application from the Main screen and choosing the Applications tab on the bottom row. This application allows adjustments to the calibration settings, programs, favorites, troubleshooting and service settings. The calibration applications, along the top row, are protected by the Calibration password. Access to these applications will allow the user to calibrate the internal transducers and apply a head correction. The service applications, along the bottom row, are protected by the Service/Admin password. Access to these applications are used for servicing and upgrading the instrument.

In order to access the Service and Calibration applications that are mentioned in this chapter, use the following passwords:

- **Calibration Applications: 123456**
- **Service Applications: 987654**

Upon entering the Applications tab, the top and bottom rows will be disabled and greyed (Figure 6.4.2.5-A Applications Locked). Using the keypad on the right side of the screen and entering the Calibration password will provide access to the top row of applications and the Admin application to change the Calibration password (Figure 6.4.2.5-B Calibration Unlocked). The same process, using the Service/Admin password, will allow access to the bottom row of applications (Figure 6.4.2.5-C Service Unlocked).

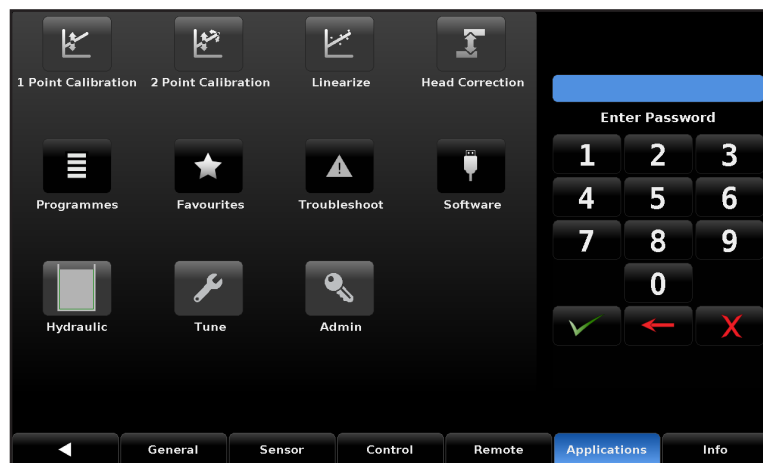

Figure 6.4.2.5-A Applications Locked

6. Operation

EN

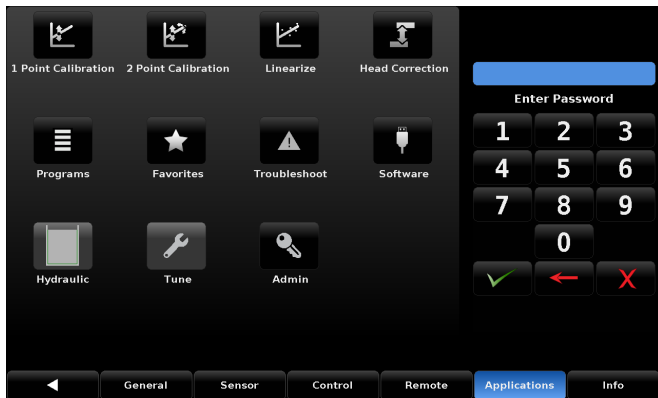

Figure 6.4.2.5-B Calibration Unlocked

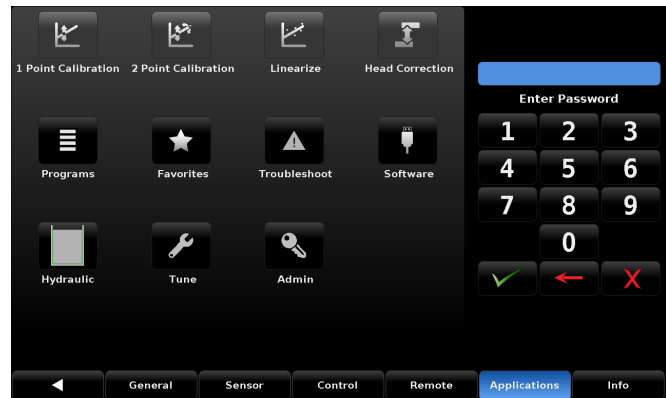

Figure 6.4.2.5-C Service Unlocked

6.4.2.5.1 1 Point Calibration

The 1 Point Calibration screen provides a place to calibrate an internal transducer or the optional barometer using a single pressure point. This is usually done to adjust the zero point of a transducer. Choose the transducer to be calibrated by pressing the [Primary], [Secondary], or [Barometer] tab at the bottom of the screen (see Figure 6.4.2.5.1-1 below). Note: A transducer position box will appear grey if a transducer is not installed in the instrument or if pressure is greater than the transducer's range.

Before calibrating an Absolute transducer, attach a high accuracy reference transducer or a pressure calibration standard to the Measure/Control port of the CPC8000-H. Refer to Section 6.4.2.5.4 to adjust the head correction of the reference sensor to the Measure/Control port.

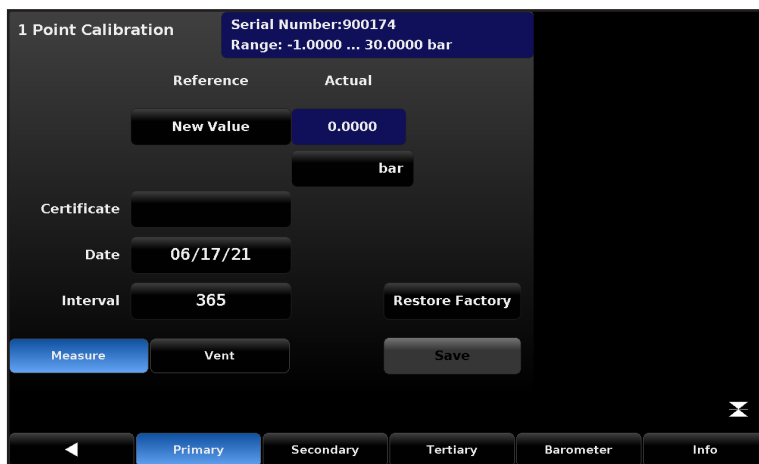



Figure 6.4.2.5.1-1 Point Calibration

To calibrate a Gauge or Bidirectional transducer, vent the instrument to atmosphere by pressing the [Vent] button. Wait until the pressure reading in the 'Actual' box becomes stable. After a stable pressure is seen, press the [New Value] button and enter 0

6. Operation

(zero) on the numeric keypad.

To calibrate an Absolute transducer, with a high accuracy reference standard connected to the Measure/Control port on the back of the CPC8000-H hydraulic module, select the [Measure] button. Once a stable pressure is reached, select the [New Value] button and enter the value from the high accuracy reference standard on the numeric keypad and click the check mark 

EN

A certificate number can be entered by pressing the [Certificate] button. The date can be entered by pressing the [Date] button. The calibration interval can be viewed and changed by pressing the [Interval] button.

After all changes have been completed, press the [Save] button to save the new calibration.

6.4.2.5.2 2 Point Calibration

The 2 Point Calibration screen is a password protected application (see Section 6.4.2.5) which allows for the adjustment of both the “zero” (low point) and the “span” (high point) of the active transducer. Choose the transducer to be calibrated by pressing the [Primary], [Secondary], or [Barometer] tab at the bottom of the screen (see Figure 6.4.2.5.2-1 below). Note: A transducer position box will appear grey if a transducer is not installed in the instrument or if the pressure is greater than the transducer’s range.

Before calibrating an Absolute transducer, attach a high accuracy reference transducer or a pressure calibration standard to the Measure/Control port of the CPC8000-H. Refer to Section 6.4.2.5.4 to adjust the head correction of the high accuracy reference sensor to the Measure/Control port.

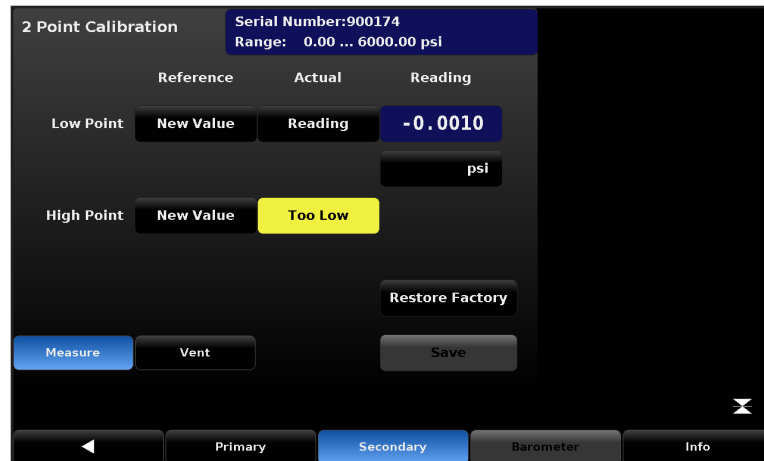



Figure 6.4.2.5.2 Two Point Calibration

Follow the steps below for a complete Two Point Calibration:

To calibrate the “Low Point” :

- For a Gauge or Bidirectional transducer, press the [Vent] button and allow the pressure reading under the ‘Reading’ label to stabilize. When the pressure is stable, select the [Reading] button under the ‘Actual’ label in the row labeled ‘Low Point’. This action will record the value under the ‘Reading’ label and it will appear with a green background where the [Reading] button was.
 - For an Absolute transducer, with a high accuracy reference standard connected to the Measure/Control port on the back of the CPC8000-H hydraulic module, select the [Measure] button. Once a stable pressure is reached, select the [New Value] button and enter the value from the high accuracy reference standard on the numeric keypad and click the check mark .
1. When the pressure is stable, select the [Reading] button under the ‘Actual’ label in the row labeled ‘Low Point’. This action will record the value under the ‘Reading’ label and it will appear with a green background where the [Reading] button was.

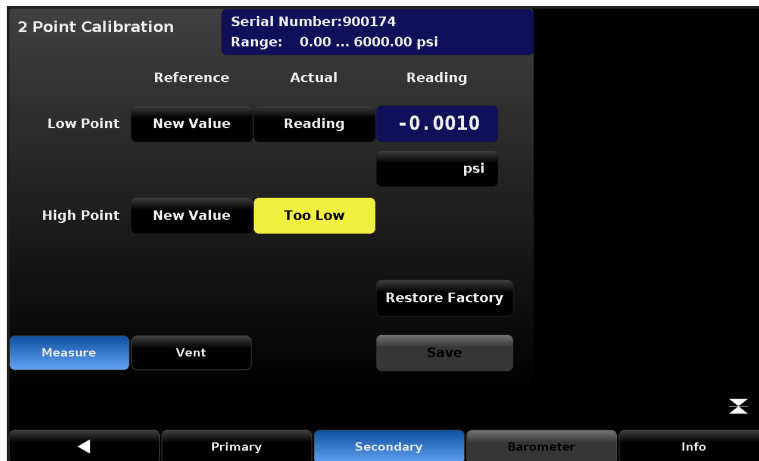

Figure 6.4.2.5.2-2 – Low Point ‘Reading’

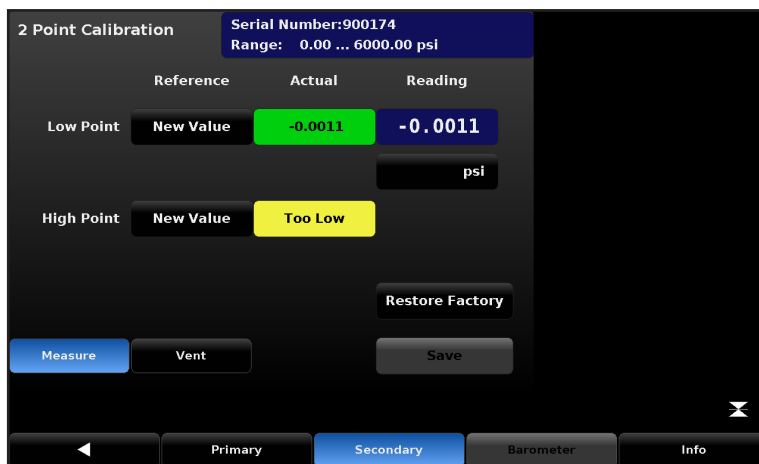

Figure 6.4.2.5.2-3 – Low Point ‘Actual’

2. Press the [New Value] button to the right of the ‘Low Point’ label and via the numeric keypad, enter the “true pressure” obtained from the calibration standard. Enter zero (0) for Gauge transducers in the numeric keypad, otherwise the value should be obtained from the pressure measured by the calibration standard. Press the check mark [✓] on the numeric keypad and the value will appear with a green background where the [New Value] button was.

This completes the ‘Low Point’ Calibration.

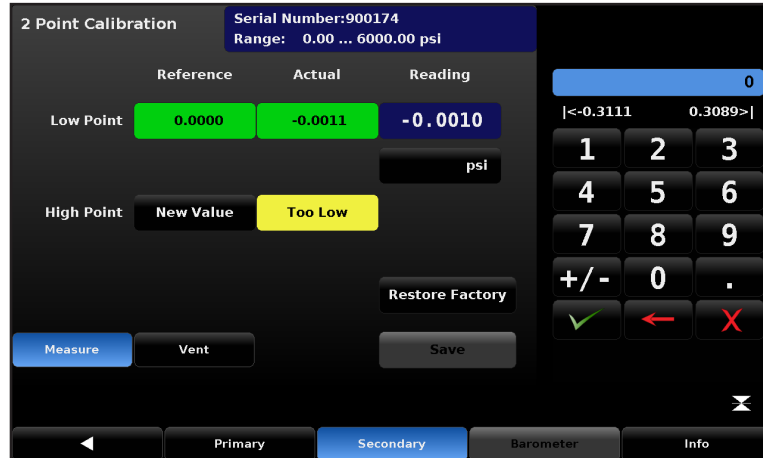

Figure 6.4.2.5.2-4 – Low Point ‘Reference’

To calibrate the “High Point”:

1. The “High Point” Calibration is done in a similar way as the “Low Point” but should be performed in [Measure] mode.
2. Place the instrument in Measure mode by pressing the [Measure] button within the 2 Point Calibration Screen.
3. Supply a pressure to the Measure/Control Port using a pressure standard. The pressure should
4. be set between the maximum span and no less than 20% of the maximum span. The [Too Low] button will change to a [Reading] button when the pressure reaches an acceptable range. See Figure 6.4.2.5.2-4
5. After the pressure stabilizes, press the [Reading] button to record the instrument’s reading of the pressure input. This action will record the value under the ‘Reading’ label and it will appear with a green background where the [Reading] button was..

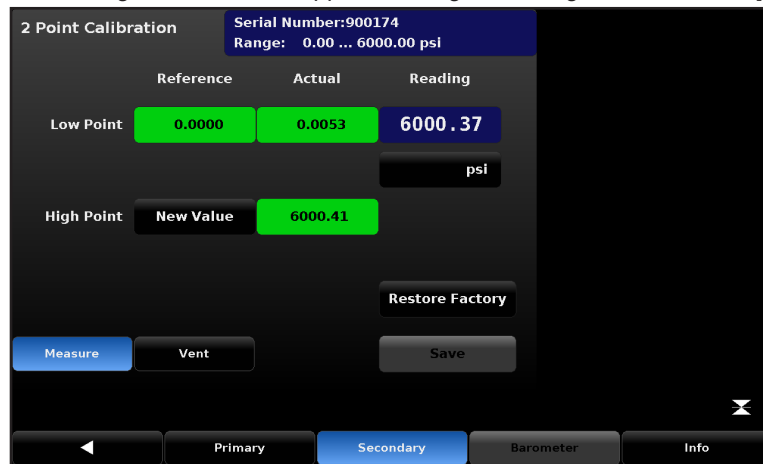

Figure 6.4.2.5.2-6 – High Point ‘Actual’

6. Press the [New Value] button and enter the “true pressure”. This value is obtained from the pressure measured by the calibration standard. After the value has been accepted by pressing the check mark [✓] on the numeric keypad, the value will appear with a green background where the [New Value] button was. This completes the ‘High Point’ calibration. See Figure 6.4.2.5.2-6
7. The [Save] button will now be active, press it to store the values in the transducer. A dialog box will appear on the right to confirm if the calibration was successful or not.

PN 0018708001J 03 / 2024 EN

6. Operation

EN

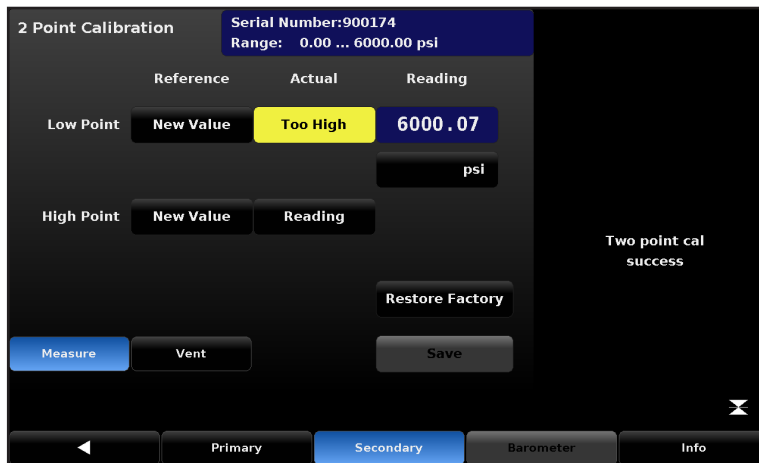

Figure 6.4.2.5.2-8 – 2 Point Calibration Success

8. If the calibration is not successful, the ratio of the span is less than 99% or greater than 101% of the span, The Reference Low Point is greater than the Reference High Point, or the intercept from the calculation is outside of the positive and negative range. Determine why the failure occurred and then try again.

$$\text{Ratio of Span} = \frac{\text{Reference High} - \text{Reference Low}}{\text{Actual High} - \text{Actual Low}}$$



Figure 6.4.2.5.2-9 – ‘2 Point Calibration Failure’]

The Restore Factory button will return the Span and Zero offset to their original values. This can be done at any time to revert back to the transducer's original calibration. The current offsets can be displayed on the Info tab.

6.4.2.5.3 Linearize

The linearization calibration application provides a place to record upscale and/or downscale calibration data and to linearize each device using that data. Refer to Section 8.2 for Recalibration setup.

• As Found

An “as found” calibration can be performed by connecting a suitable pressure standard to the Measure/Control port, placing the instrument in Measure mode and supplying 3 to 11 pressure points across the complete range of the transducer being calibrated. The pressures generated or measured by the pressure standard and the corresponding reading from the instrument's transducer can be recorded and transcribed into the Linearize / As Found screen. The screen is accessed by pressing the As Found button in the Linearize screen (Figure 8.2.9 Linearization). In the Linearize / As Found screen choose the transducer to be linearized by

PN 0018708001J 03 / 2024 EN

6. Operation

pressing the Primary, Secondary, or Barometer button. Pressure test points generated by the reference standard are entered in the column labeled “Reference”; each of the corresponding readings from the instrument’s transducer should be entered into the column labeled “Actual”. To enter readings, simply press the corresponding point in the “Reference” or “Actual” columns and a data entry keypad will appear on the side bar. Enter and accept the point using the key pad and check mark. Pressing the Save button linearizes the internal transducer based on the “As Found” data entered.

EN

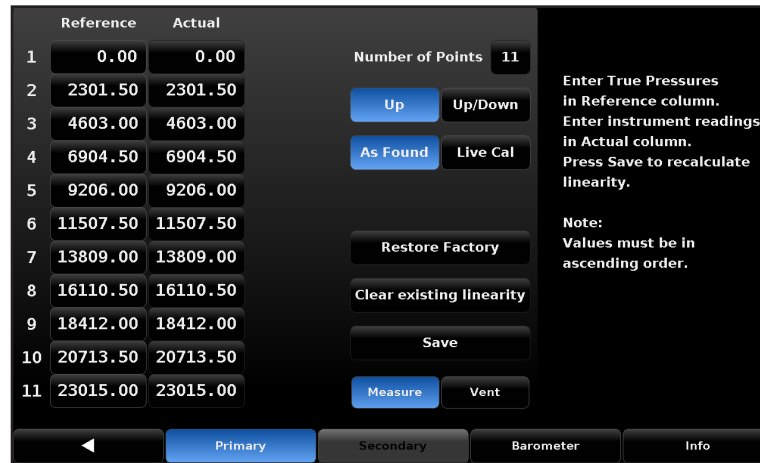

Figure 6.4.2.5.3 Linearization

• Live Cal

Linearization can also be accomplished for each transducer in a live Calibration by pressing the "Live Cal" button. The Live Cal allows the calibration technician to perform the calibration and linearization for each transducer in a more direct way. In the Live Cal application, the reference standard is connected to the Measure/Control port and the CPC8000-H is placed in Measure mode. Choose the transducer to be tested by pressing the Primary, Secondary, or Barometer button. The reference pressure generated by the standard is recorded in the “Reference” column for each point. The reading of the internal transducer for each pressure point can be seen directly in the “Reading” window. Pressing the corresponding point under the “Actual” column will accept that reading into that point. Subsequent pressure points generated by the pressure standard are accepted and recorded in the same way. After all points are entered, press the Save button to linearize the internal transducer based on the “Live Cal” data.

At any time the [Factory Cal] button can be pressed to revert back to the factory calibration.

• Remote Linearization

The Reference points and Actual points can also be sent over the remote bus for automated transducer linearizations. Set each reference pressure with the command “Desiredpress <n>,<pressure>” where <n> is the 0th based index. “Desiredpress 0,0” will set the 1st Reference point’s value to 0. “Desiredpress 1,1.5” will set the 2nd reference point to 1.5, etc. Each subsequent reference point must be greater in value than the previous point. It is advised to send all of your Reference points first before proceeding. Use your reference to control the pressure on the measure port to the Reference/desired pressure. Then send the pressure reading over the bus with the command “Actualpress <n>,<reading>” where <n> is the 0th based index. This reading should be within +/- 1%FS of the Reference point. Send each of the 3 to 11 readings with the “Actualpress” command and then send “Calculate_as_found_linearity” and then “Save_linearity”. Your active transducer linearization is now complete.

6.4.2.5.4 Head Correction

The Setup [] / [Applications] / [Head Correction] screen is the place to enter parameters that affect the offset that occurs when the device is being calibrated and located at a different level (elevation) compared to the transducer inside of the CPC8000-H.

Touching any of the active buttons in this screen will activate the number key pad. Each of the four rows in figure 6.4.2.5.4 represent a different parameter in the head correction calculation. In the [Height (INST-DUT)] row, the level of the Device Under Test (DUT) should be subtracted from the instrument reference point (INST) and entered. The gas density used within the calibration system, the gas temperature, and the local gravity should be entered in the subsequent fields. The default height is zero

(0) indicating that there is no head correction applied. [English] or [Metric] units can be chosen by pressing the related button.

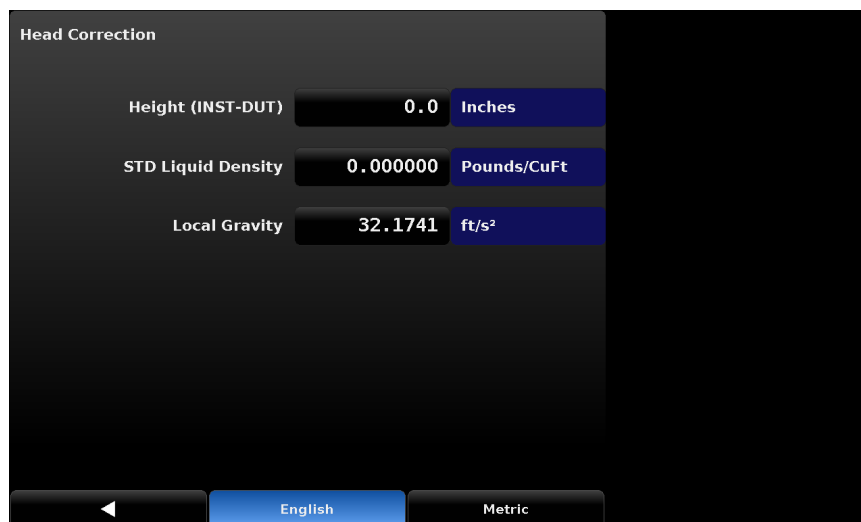

Figure 6.4.2.5.4 Head Correction

6.4.2.5.5 Programs

The Programs application is accessible in the Applications tab. This application is used to create, view and edit programs that are used to automatically run a sequence of commands within the CPC8000-H. There are two tabs at the bottom of the Program screen shown in Figure 6.4.2.5.1-A. The Display tab provides a place to view each program or add a new one. Pressing the program button at the top left will allow the sidebar to be displayed on the right side of the screen. Each CPC8000-H will have preloaded programs that can be used, seen as examples, edited/modified or deleted. There are also blank buttons that allow the user to create new programs. When a program is selected, it will become highlighted and the sequence of commands will be displayed on the left two-thirds of the screen. The sequence can be scrolled through by using the Up/Down arrows located at the top of the screen.

The Edit tab (Figure 6.4.2.5.1-B), allows the user to edit existing programs or create steps in new ones. To create a new program, select the box in the top left hand corner while in Display tab. Select a blank box and then switch the to Edit tab. Selecting the blank box in the top left hand corner will now allow you edit the name of the new program. Pressing a command or data point will present the available commands or data entry type in the side bar. The Insert/Delete buttons allow insertion or deletion of commands and data entries. Selections of commands and data in each sequential line will create a sequence of commands that will be processed when a program is selected on the Main screen. Once you exit the Edit menu, the instrument will prompt the user to "Replace old values?". Pressing the will accept the changes, and pressing the will revert back to the old program. A list of the available commands, data values and functions are shown below.

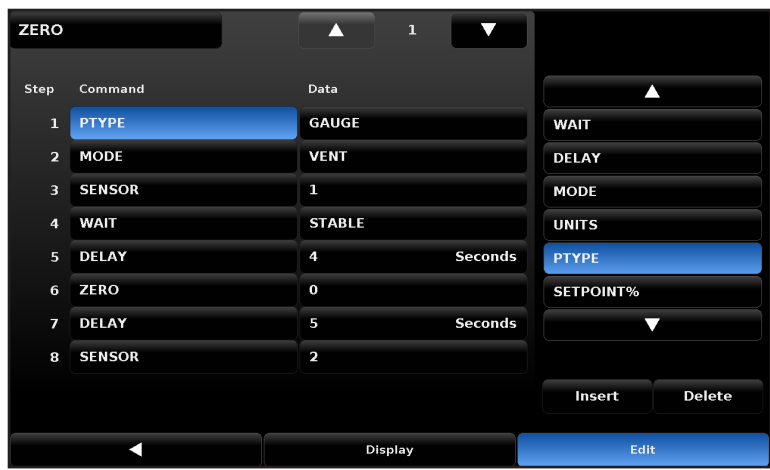

Figure 6.4.2.5.5-B Edit Programs

Program Commands	
DELAY	Delays for time = 1 to 3600 seconds (Numerical Entry)
LOOP	Loops back to a selected line for a selected number of iterations (Numerical Entry)
MODE	Sets the control mode (Measure, Control, or Vent)
PTYPE	Sets the pressure type (Gauge or Absolute)
RSETPT	Sets the rate setpoint in the current units (Numerical Entry)
RUNITS	Sets the rate denominator time unit (min or sec)
SENSOR	Sets the active transducer (1,2, or 3)
SEQSTART	Starts the sequence from the beginning (None)
SETPOINT	Sets the control setpoint for the instrument (Numerical Entry)
SETPOINT%	Sets the control setpoint in % of the primary range (Numerical Entry)
STEP	Increases or decreases the current setpoint in current units (Numerical Entry).
STEP%	Increases or decreases the current setpoint by the percent full scale specified.
WAIT	Waits for a manual input or stable condition (Stable or Input)
ZERO	Zero's active sensor (None)

6.4.2.5.6 Favorites

The Favorites application is accessible on the Applications tab. When the Favorites button is pressed, the current list of favorites will be shown in a list (Figure 6.4.2.5.2). The selection bar on the right side of the screen will list all available programs saved to the CPC8000-H. By selecting one of these, it will replace the highlighted row on the left with the selected program. These will be accessible on the main screen using the Favorites button.

6.4.2.5.7 Troubleshoot

The Troubleshooting application is accessible on the Applications tab. This application is used to observe any mechanical failures, software errors, or remote communication errors. The two tabs on the bottom of the screen allow the user to view the error log or remote log (Figure 6.4.2.5.3). The Errors display is active upon entry of the Troubleshooting application. Any error messages will be erased after they have been viewed. The Remote log is accessed by pressing the Remote tab on the bottom right of the screen. The remote log displays all commands and responses sent and received by the CPC8000-H. These two menus are helpful in de-bugging and troubleshooting remote control software programs. The back arrow is used to return to the main Applications settings screen.

6.4.2.5.8 Software

PN 0018708001J 03 / 2024 EN

The Software application [] (available on software V1.34 or newer) is used to upgrade the instrument, regulator, and GPIB software via USB. This application is also used to load and copy Programs and Regulator Configuration files to/from USB. This application is unlocked by entering the Service/Admin password.

EN Instrument Software: Displays the current software on the controller. If you have a USB drive in the front or rear panel, you will be able to select this button. It will show you the available software versions that are on the USB drive.

Copy Programs to USB: This button will copy the programs from the CPC8000-H programs application to the USB drive and store them in the root directory in a folder named “seq.” Each program will be stored within that folder as a .txt file.

Load Programs from USB: This button will load the programs that are stored on the USB drive to the CPC8000 and overwrite any current programs that are on the device.

Regulator Software: This will display the current version of regulator software. When selected, a list of regulator versions will be available for installation if they are on the USB drive.

Copy Regulator Configuration Files: This function will create a xxxxxx.txt file (where xxxxxx is the regulator serial number) that contains the unique coefficients that allow the regulator inside the instrument to operate. It is good practice to back up the regulator configuration file before upgrading software and/or changing regulator parameters.

Load Regulator Configuration Files: This function will load the selected regulator configuration file that is stored on the USB. Be sure to select the regulator configuration file that matches the serial number of the regulator. The serial number can be found in the Settings > Info application.

Remove USB Device: This will safely unmount the USB drive.

Status: Displays whether or not a USB drive is available.



Figure 6.4.2.5.8 Application - Software

6.4.2.5.9 Hydraulic

The Hydraulic Application can be used to manually control the Vent and Second Sensor valve, as well as the priming pump. This application is useful for bleeding air out of the DUT and diagnosing the functionality of the valves, sensors, and pump. This application is unlocked by entering the Service/Admin password.

By default, Sensor 1 is selected. If a second sensor is present, selecting Sensor 2 will open the Sensor 2 valve to allow Sensor 2 to sense pressure. Selecting the Measure button will close the Vent valve and put the unit in Measure Mode. Any pressure applied in Measure Mode will not be released until switched back into Vent Mode.

Selecting the pump button will actuate the priming pump inside the hydraulic module. The pump will prime to a max of 2.5x the flooding pressure as indicated on the Flooding regulator gauge.

Three programs are also available in this application: "Pump X Times", "Pump Indefinite", and "Empty Reservoir".

- **Pump X Times:** Selecting this program will open a keypad on the right hand side of the screen. Enter the number of times you want the unit pump and press the check mark. Then press the play button to start the sequence. The sequence can be stopped by pressing the Stop button.
- **Pump Indefinite:** Select this program if you wish to have the unit pump indefinitely. Press the play button to start the sequence. The sequence can be stopped by pressing the Stop button.
- **Empty Reservoir:** This program is to be used by service centers to change the hydraulic media inside the hydraulic module.

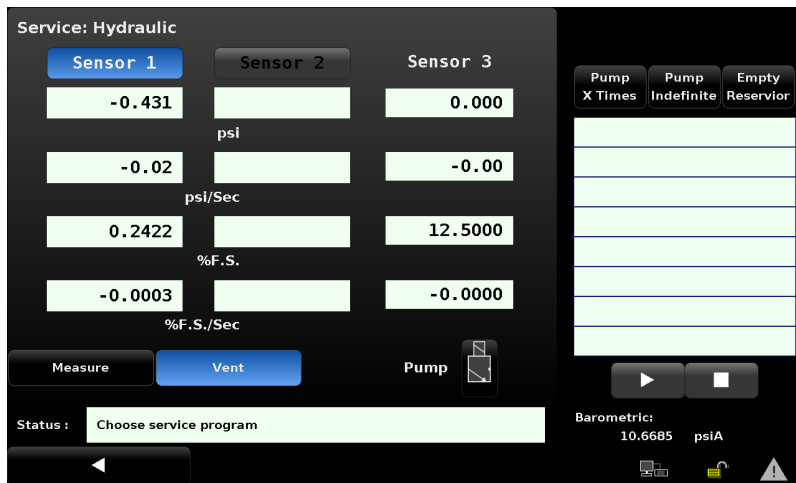

Figure 6.4.2.5.9 Application - Hydraulic

6.4.2.5.10 Tune

The Setup [🔧] / Applications / Adaptation tab and its sub tabs Seal Point Characterize, Linearity Graphs and Gain Test should only be used with close supervision from Mensor Customer Service. Changing parameters within this section will change the regulator response and may cause the CPC8000-H to fail to meet control specifications or output pressure that could damage externally connected instruments. The Tune application can be unlocked by entering the Service/Admin password.

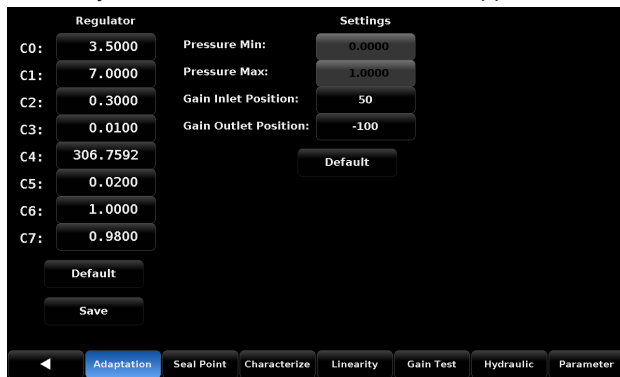

Figure 6.4.2.5.10-A

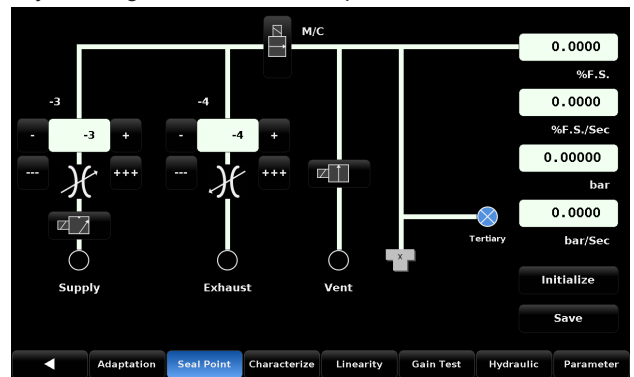
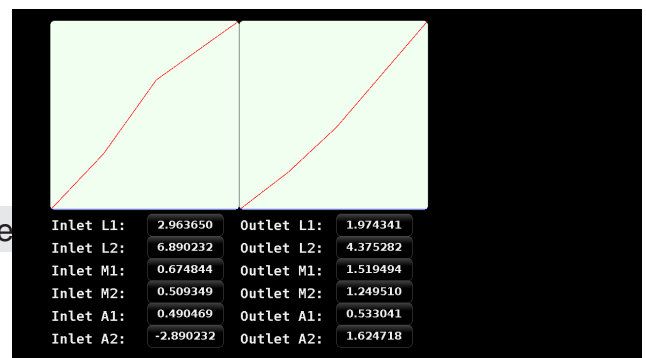

Figure 6.4.2.5.10 - B

	0	1	2	3	4	6	8	10	
11.111111	Ready
22.222222	
33.333333	%F.S.
44.444444	0.0000
55.555555	%F.S./Sec
66.666666	
77.777777	Inlet Outlet
88.888888	Autotune Leak Test
99.999999	Start
...	Only Autotune



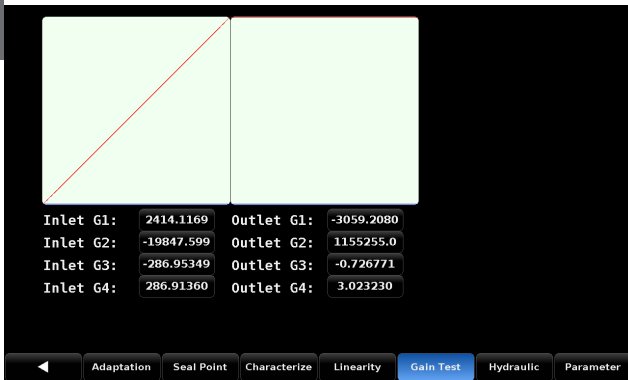

Figure 6.4.2.5.10-E

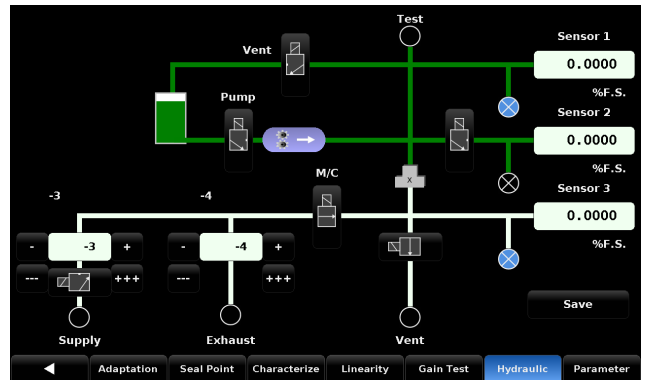

Figure 6.4.2.5.10-F

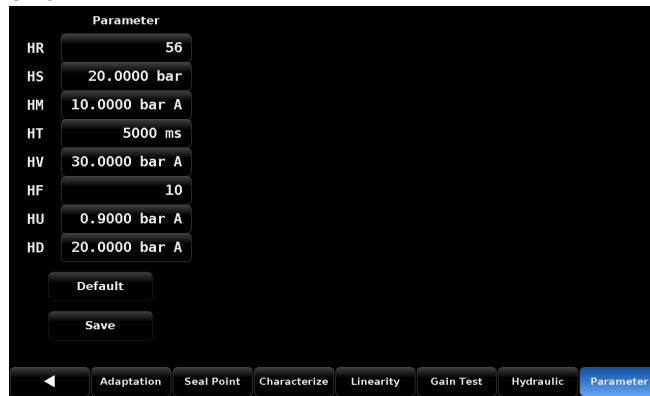

Figure 6.4.2.5.10-G

6.4.2.5.11 Admin

The Setup [🔧] / [Applications] / [Admin] application has a place to change the Calibration and Service passwords. Passwords can be changed by selecting the Calibrate or Service button on the left and entering the new password on the right. Confirm the password change by selecting the green check mark. The new password will now be active.

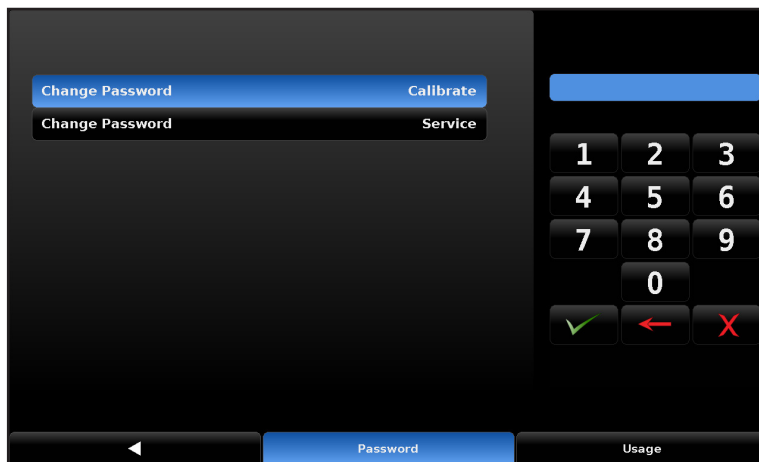

Figure 6.4.2.5.11 Admin

6.4.2.5.12 Troubleshooting

The Troubleshooting application is accessible on the Applications tab. This application is used to observe any mechanical failures, software errors, or remote communication errors. The two tabs on the bottom of the screen allow the user to view the error log or remote log (Figure 6.4.2.5.3). The Errors display is active upon entry of the Troubleshooting application. Any error messages will be erased after they have been viewed. The Remote log is accessed by pressing the Remote tab on the bottom right of the screen. The remote log displays all commands and responses sent and received by the CPC8000-H. These two menus are helpful in de-bugging and troubleshooting remote control software programs. The back arrow is used to return to the main Applications settings screen.

EN

7. Remote Operation

7. Remote Operation

7.1 Remote Operating Parameters

EN

Use the screens in Section 6.4.2.4 Remote Settings to set the remote operating parameters for the instrument command set, Ethernet, Serial (RS-232) and IEEE-488 (GPIB) communications.

7.2 Command Set

Command Set button – Users' can select which model remote protocol they would like to emulate for simulation and testing purposes. Selections may include the following or may be added per customers' specifications:

- Mensor
- Wika SCPI

7.3 IEEE-488

IEEE-488 address button – Allows the user to set the GPIB address by inputting a numeric value utilizing the touch screen.

7.3.1 IEEE-488.2 Commands

Command	Response/ Function
*IDN?	Returns identification string

7.4 Ethernet

The Ethernet function allows the user to set the following by inputting a numeric value in each separate field:

- IP
- Netmask
- Gateway
- Port
- DHCP settings

Set the Ethernet communication parameters as described in 6.4.6 Remote Settings Application.



CAUTION! Please contact your network administrator for proper settings.



CAUTION! Please consult your computer resources department prior to connecting this instrument to your network to verify there are no conflicts with existing IP addresses.

The Ethernet communication port allows the CPC8000-H to communicate with computers using 10/100 Based-T specifications. Before using Ethernet communication, four parameters must be present: IP, Netmask, Gateway, and Port.

7. Remote Operation

7.5 Serial

Set the Serial communication parameters as shown in Section 6.4.2.4 Remote Settings. The serial communication port allows the CPC8000-H to communicate in RS-232 format with computers, terminals, PDAs, or similar hosts.

These parameters should be set to match your host computer. Default settings are: 57600 baud, 8 data bits, 1 stop bit, no parity, and no echo.

If echo is ON, the CPC8000-H will immediately echo back characters sent over the serial port. The Serial function allows the user to set the RS-232 serial port settings by selecting from the choices provided:

- Baud
 - ⇒ 9600
 - ⇒ 19200
 - ⇒ 38400
 - ⇒ 57600
 - ⇒ 115200
- Data Bits
 - ⇒ 7
 - ⇒ 8
- Stop Bits
 - ⇒ 1
 - ⇒ 2
- Parity
 - ⇒ Even
 - ⇒ Odd
 - ⇒ None
- Echo settings
 - ⇒ On
 - ⇒ Off

7.5.1 Serial Cable Requirements

RS-232 communications are transmitted over a three conductor, shielded cable terminated in a standard DB9 connector on the instrument end, and a different gender connector on the host end. The proper pin-outs are shown in the following illustration.

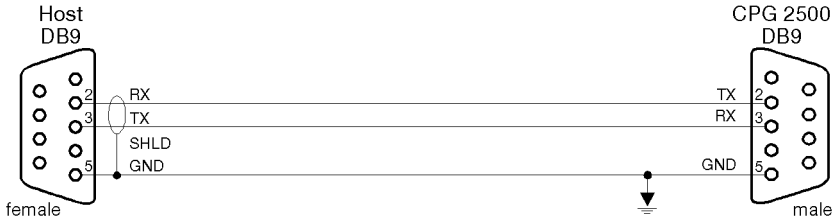

7. Remote Operation

7.6 Mensor Command Set

This Mensor command set is the default on the CPC8000-H. For queries (ending with a ?), the Data column represents the response of the CPC8000-H. All response strings begin with a space character or an "E" representing that there is an error in the error queue. All response strings are terminated with a termination character set in the Remote Settings Screen (Section 6.4.2.4 Remote Settings). The error queue holds the last 10 errors identified.

For all commands (no ?), the data column represents the required parameters to be sent to the CPC8000-H following the string in the command column. For any command that requires multiple parameters to be sent, the parameters must be separated by commas.

7.6.1 Command and Query Format

Commands must be sent in ASCII format and terminated with either a carriage return (<cr>), linefeed (<lf>), or both. Commands are not case sensitive. Each query returns a response. If an error is detected the response will include an error flag.

Command or Query field: Unless otherwise specified, commands are typically converted to queries by appending a question mark to the command. Table 7.10 lists all of the CPC8000-H command or query keywords.

Data field: The data field is either in ASCII {string} or numeric {value} form. In the case of multiple data fields, commas are required to separate the fields. Queries do not have a data field. String (text) or value (numeric) data are acceptable in any of the following formats:

Examples of {string} data: ON, OFF, mBar, inHg

Examples of {value} data: 1, 1.0, -5.678, 25.68324e-5

7.6.2 Command Set Definitions

In this manual a data entry made up of alpha characters is defined as a string, as opposed to data containing only numbers, such as "Enter 1" for ON or "0" for OFF where 1 and 0 are defined as values.

Command: Any command or query listed in Table 7.6.4. For commands that take boolean data the following strings are acceptable:

0	1
False	True
No	Yes
Off	On

Separator: Space (SP).

Data: ASCII representations of numbers, {value}, or alpha characters, {string}, data as defined above. When sending code a literal variable replaces the brackets and the enclosed character(s) shown in the following examples.

Termination: Linefeed (LF) or carriage return (CR) is used to signal the end of a command statement. For IEEE-488.2 operation "EOI" is an acceptable alternative.

Always send commands in one of the following formats:

1. [Command] [Termination];
2. [Command] [Separator] [Data] [Termination];
3. Queries are special instructions in the form: [Command?] [Termination] where the question mark, "?", immediately precedes the terminator.

When a valid query is received, the CPC8000-H will return {data} terminated by termination character set in the Remote Settings Screen (Section 6.4.2.4 Remote Settings). Floating point data is returned in the current engineering units in exponential format.

7.6.3 Output Formats

Pressure readings are returned in exponential notation in a format according to the OUTFORM command as follows.

Output formats

1. <sp> pressure value <cr><lf>
2. <sp> pressure, units, mode <cr><lf>
3. <sp> pressure, pressure rate <cr><lf>
4. <sp> pressure, minimum peak, maximum peak <cr><lf>
5. <sp> pressure, active sensor (P or S), active turndown (1-4) <cr><lf>
6. <sp> pressure, control point, "stable" or "slewing" <cr><lf>
7. <sp> pressure, "no barometer" or baro reading <cr><lf>

EN

PN 0018708001J 03 / 2024 EN

7. Remote Operation

7.6.4 Mensor Commands and Queries

Table 7.6.4 lists all of the current Mensor commands and queries.

Table 7.6.4

Command/Query	Data	Function/Response
?	See Table Below	Returns data per the current output format.
Absolute?	<sp>YES or NO<cr><lf>	Returns if the primary transducer is native absolute
Accuracy?	<sp>n.nnnnnE+nn<cr><lf>	Returns the fullscale accuracy of the active sensor. Deprecated command for backwards compatibility. See "Accuracyst?"
Accuracyst?	Up to 16 character string	Returns the accuracy string of the active sensor, e.g. 0.010% IS-50
Acquire?	15 char string. Ex: Acquire? Test_stand_1 Returns: <sp>(YES or NO), CCC... CCCcr><lf>	This command is used when multiple computers would like to control the instrument. Yes if acquisition is successful. No if instrument is being controlled with another computer. CCC... = name of controlling computer. See: Release? and Unlock
Actualpress?<sp><n>	<sp>+n.nnnnnE+nn<cr><lf>	Returns the actual sensor pressure for the specified segment n
Actualpress<sp><n>,<f>	Number which must be between the values of segment n-1 and n+1. End points must be within 1% of the minimum and maximum of the range's span.	Used for a linearity calibration fix. Sets the internal sensor's pressure for segment n. N is 0 to 9. See "Calculate_as_found_linearity"
Address	0-31	Sets the GPIB Address.
Address?	<sp> nn <cr><lf>	Returns the GPIB Address.
All?	<sp>+n.nnnnnE+nn,..., +n.nnnnnE+nn <cr><lf>	Returns pressure readings of all transducers on the active channel, including the barometer
Asset_tag	16 char string	General purpose string for customer use.
Asset_tag?	<sp>ssssssssssssss<cr><lf>	Return customer asset tag string.
Autorange	ON or OFF	Sets whether the autorange function is enabled or disabled

7. Remote Operation

EN

Autorange?	<sp>(ON or OFF)<cr><lf>	Returns whether the autorange function is enabled or disabled.
Autozero	none	Re-zero all the ranges. These adjustments are not password protected and are saved through power cycles. This command takes approximately 60 seconds but may take longer depending on the time to become stable. CALDISABLE must be OFF/NO.
Autozero?	<sp>S,T,X,X<cr><lf>	Returns autozero data where S represents state (0 = complete, 1 = local autozero, 2 = remote autozero), T represents the estimated time to complete in seconds, and x is a (0) character since this data location is not used at this time
Autozeroabort	none	Aborts autozero. Any transducers that have been zeroed will not revert to previous zero offsets.
AUXDISP	NONE,PEAK,RATE,RATE SETPOINT,DIGITAL I/O,UNITS,TARE,UNCERTAINTY	See "Auxdisp1"
AUXDISP?	<sp>NONE,PEAK,RATE,RATE SETPOINT,DIGITAL I/O,UNITS,TARE,UNCERTAINTY<cr><lf>	Returns the secondary alternate function mode, works identical to AUXDISP2 (kept for backwards compatibility).
AUXDISP1	NONE,PEAK,RATE,RATE SETPOINT,DIGITAL I/O,UNITS,TARE,UNCERTAINTY	Sets the first auxiliary display selection..
AUXDISP1?	<sp>NONE,PEAK,RATE,RATE SETPOINT,DIGITAL I/O,UNITS,TARE,UNCERTAINTY<cr><lf>	Returns the first auxiliary display selection.
AUXDISP2	NONE,PEAK,RATE,RATE SETPOINT,DIGITAL I/O,UNITS,TARE,UNCERTAINTY	Sets the second auxiliary display selection.
AUXDISP2?	<sp>NONE,PEAK,RATE,RATE SETPOINT,DIGITAL I/O,UNITS,TARE,UNCERTAINTY<cr><lf>	Returns the second auxiliary display selection.

PN 0018708001J 03 / 2024 EN

7. Remote Operation

EN

Baro?	<sp>+n.nnnnnE+nn<cr><lf>	Returns reading from barometric sensor or “NO BAROMETER” if one isn’t installed
Baroid?	<sp>Mensor,SN XXXXXX, VN.NN<cr><lf>	Returns identification string for the barometer.
Barocaldisable	YES,NO	Not applicable to the CPC 8000
Barocaldisable?	<sp>(YES or NO)<cr><lf>	Not applicable to the CPC 8000
Barounits	Units code or text in table below	Sets the barometer engineering units. Note: this only effects the displayed output on the screen, not any remote responses.
Barounits?	<sp>CCCC<cr><lf>	Returns the barometer units in a text string
Brightness	0-100	Set the brightness of the screen from 0 to 100%
Brightness?	<sp>nn<cr><lf>	Get the brightness of the screen
Calculate_as_found_linearity		Calculate linearity slopes and intercepts from true/actual pressures, and loads the linearity correction coefficients to the transducer. See “ActualPress” and “TruePress”.
Caldisable	YES,NO	Sets whether or not calibration of the active transducer is disabled.
Caldisable?	<sp>(YES or NO)<cr><lf>	Returns whether or not calibration of the active transducer is disabled.
Chanfunc	Press, peak, rate, rate setpt, dio, units	Sets the secondary display function mode, works identical to Chanfunc2
Chanfunc?	<sp>CCCC...<cr><.lf>	Returns the secondary alternate function mode, works identical to Chanfunc2
Chanfunc2	Press, peak, rate, rate setpt, dio, units	Sets the secondary display function mode Chanfunc2
Chanfunc2?	<sp>CCCC...<cr><.lf>	Returns the secondary alternate function mode Chanfunc2
Chanfunc3	Press, peak, rate, rate setpt, dio, units	Sets the tertiary display function mode Chanfunc3
Chanfunc3?	<sp>CCCC...<cr><.lf>	Returns the tertiary alternate function mode Chanfunc3
Cerr	none	Clears the error queue.
Cmdset	Mensor, DPI510, DPR60c, SCPI	Activates remote command set for instrument emulation modes.
Cmdset?	<sp><CCCCCC><cr><lf>	Returns active command set identifier.
Control		Instrument placed in Control Mode
Control?	<sp>(YES or NO)<cr><lf>	Returns YES if instrument is in control. No if otherwise.
Crate	Slow, Medium, Fast, Variable	Sets the control rate. Variable mode is a predetermined user-defined rate setpt.

PN 0018708001J 03 / 2024 EN

7. Remote Operation

EN

Crate?	<sp>CCCCCC<cr><lf>	Returns the control rate – CCCC is variable in length and corresponds to the parameters for the CRATE command.
Ctype?		Returns the type of regulator.
Decpt?	<sp>n<cr><lf>	Returns the number of decimal points. (See Resolution)
Default	none	Sets the default values.
DesiredPress	N, f	Set the active sensor's desired pressure in active units for linearity correction at segment N to value f. N must be an integer from 0 to the number of selected linearity points (see "Linearity_Pts").
DesiredPress? N	<sp>+n.nnnnnE+nn<cr><lf>	Returns the active sensor's desired pressure for segment N.
DHCP	ON or OFF	Reserved for DHCP setup
DHCP?	<sp>(YES or NO)<cr><lf>	Reserved for DHCP setup
Error?	<sp> text description <cr><lf>	Returns the next error in the error queue.
Errorno?	<sp>Enn-text<cr><lf>	Returns pcs400 error code and text
Filter	Off, Low, Normal, High	Sets the reading filter 0, 80%, 92%, 95%.
Filter?	<sp> (filter)<cr><lf>	Returns the reading filter.
FilterWin	nnn	Set the filter window as a floating point value in pressure
FilterWin?	<sp>+n.nnnnnE+nn<cr><lf>	Returns the filter window
Gasdensity	Value in lb/cuft, or "NITRO-GEN" or "DRYAIR"	Sets the head pressure gas density in lb/cuft
Gasdensity?	<sp>+n.nnnnnE+nn<cr><lf>	Gets the head pressure gas density in lb/cuft
Gastemp	Value in degrees F	Sets the head pressure gas temperature
Gastemp?	<sp>+n.nnnnnE+nn<cr><lf>	Gets the head pressure gas temperature
Gateway	nnn.nnn.nnn.nnn	Sets the Ethernet gateway address.
Gateway?	<sp>nnn.nnn.nnn.nnn<cr><lf>	Gets the Ethernet gateway address.
Gauge?	<sp>YES or NO<cr><lf>	Returns if the primary transducer is native gauge
HeadHeight	Value	Sets the head pressure height in active head pressure correction length units, which is either imperial (inches) or metric (cm)
HeadHeight?	<sp>+n.nnnnnE+nn<cr><lf>	Get the head pressure height in active head pressure correction length units, which is either imperial (inches) or metric (cm)
Height	Value in inches	Sets the head pressure height in inches

PN 0018708001J 03 / 2024 EN

7. Remote Operation

EN

Height?	<sp>+n.nnnnnE+nn<cr><lf>	Gets the head pressure height in inches.
HYDRSN?	<sp>ccccccc<cr><lf>	Only valid for CPC8000H. Returns the hydraulic module serial number.
ID?	<sp>MENSOR,CPC8000,ssssss,v.v.vv<cr><lf>	Ssssss is the serial number,v.v.vv is the CPC 8000 software version.
INSTRUMENT_TIME_ON?	<sp>NNNNN<cr><lf>	Returns the amount of time the instrument has been on since the last reset of the counter, in minutes.
Instrument_control_time_on?	<sp>NNNNN<cr><lf>	Returns the amount of time the instrument has been in control mode since the last reset of the counter, in minutes.
Instrument_total_control_time_on?	<sp>NNNNN<cr><lf>	Returns the lifetime amount of time the instrument has been on, in minutes.
Intelliscale?	<sp>(YES or NO)<cr><lf>	Returns if the active sensor has intelliscale accuracy.
IP	nnn.nnn.nnn.nnn	Sets the IP address of the instrument.
IP?	<sp>nnn.nnn.nnn.nnn<cr><lf>	Returns the IP address of the instrument.
ISBreakpt?	<sp>+n.nnnnnE+nn<cr><lf>	Returns the intelliscale breakpoint in pressure, where the accuracy changes from %FS to %Reading
Keylock	YES or NO	Locks or unlocks the entire touch screen.
Keylock?	<sp>(YES or NO)<cr><lf>	Returns Yes or No.
Language	CCCCCCC	Set the active display language. Accepts the following: ENGL, ENGL US, ENGL CA, ENGL GB, GERM DE, GERM SZ, DEUT DE, DEUT SZ, FREN, FREN CA, FREN SZ, FREN CH, FRAN , FRAN CA, FRAN SZ, FRAN CH, SPAN MX, SPAN SP, SPAN LAT, SPAN AL,ESPA, ESPA MX, ESPA SP, ESPA LAT, ESPA AL, PORT, PORT PT, PORT BZ, PORT BR, ITAL, POL, RUS, CHI, JAP, KOR. Each language may also be completely spelled out, i.e. ENGLISH instead of ENGL
Language?	<sp>CCCCC,(ABBREV)<cr><lf>	Returns the active display language, i.e. "ENGLISH (US)" or "DEUTSCH (DE)"
Lgravity	Value in active head correction acceleration units	Sets the local gravity in either imperial (feet/sec ²) or metric (m/sec ²).
Lgravity?	<sp>+n.nnnnnE+nn<cr><lf>	Returns the local gravity in either imperial (feet/sec ²) or metric (m/sec ²).
List?	<sp>Pri,1;Sec,1;Ter,1;Bar,1<cr><lf>	Returns list of available transducers and turn-downs.

7. Remote Operation

EN

Listall?	Model, serial number, date of manu-facture, software version, OS ver-sion, GPIB version, barometer serial number, version, accuracy, calibration date; Regulator version, serial number; PRI, 1, Sensor Model, serial number, version, range minimum, range maximum, Native units, pressure type, accuracy, calibra-tion date; SEC, 1, Sensor Model, serial number, version, range minimum, range maximum, Native units, pressure type, accuracy, calibra-tion date; TER, 1, Sensor Model, serial number, version, range minimum, range maximum, Native units, pressure type, accuracy, calibra-tion date;	Returns all instrument, regulator and sensor version, ranges and calibration information. Any non-existent ranges have all associated fields as N/A.
Listcal?	<sp>PRI,{sn},1,{mmd-dyy};SEC,{sn},1,{mmd-dyy},TER,{sn},1,{mmd-dyy},BAR,{sn},{mmd-dyy}<cr><lf>	Returns list of available transducers and turndowns' calibration dates.
Listrange?	PRI,1,min,max;SEC,1,min,max;TER,1,min,max; Bar,min,max	Returns the ranges of the installed transducers.
Listsensorinfo?	PRI,SN,PTYPE,ACCURACY,1,min,max;SEC,SN,PTYPE,ACCURACY,1,min,max; TER,SN,PTYPE,ACCURACY,1,min,max	Returns the serial number, pressure type, accuracy, and ranges of all the installed sensors.
LLimit	nnn	Alias for "Lowerlimit". See Lowerlimit
LLimit?	<sp>n.nnnnnE+nn<cr><lf>	Alias for "Lowerlimit?". See LowerLimit?
Localgravity	Value in ft/s^2	Sets the local gravity in feet/sec^2
Localgravity?	<sp>+n.nnnnnE+nn<cr><lf>	Returns the local gravity in feet/sec^2
Loudness	nnn	Set the speaker volume
Loudness?	<sp>n.nnnnnE+nn<cr><lf>	Returns the speaker volume from 0 to 100%
LowerLimit	nnn	Sets the lower control limit for the instrument

PN 0018708001J 03 / 2024 EN

7. Remote Operation

EN

LowerLimit?	<sp>n.nnnnnE+nn<cr><lf>	Returns the lower control limit for the instrument in current units.
Lowovershoot		Does not apply to CPC8000.
Lowovershoot?	<sp>YES<cr><lf>	Returns YES.
Measure	None	Instrument placed in Measure Mode
Measure?	<sp>(YES or No)<cr><lf>	Returns YES if instrument is in measure. NO if otherwise
MEDIADENSITY	NITROGEN” or “DRYAIR	Set the supply pressure type to either the nitrogen gas or dry air.
MEDIADENSITY?	<sp>cccc<cr><lf>	Returns the media type
MEDIATEMP	Value	Set the media temperature in active head pressure correction units.
MEDIATEMP?	<sp>n.nnnnnE+nn<cr><lf>	Returns the media temp. in the active head pressure correction temp. units, as either imperial (F) or metric (C).
Mode	STANDBY, MEASURE, CONTROL, VENT	Sets the operation mode
Mode?	<sp>XXXXXX<cr><lf>	Returns the operation mode
Netmask	nnn.nnn.nnn.nnn	Sets the Ethernet network mask
Netmask?	<sp>nnn.nnn.nnn.nnn<cr><lf>	Gets the Ethernet network mask
NVR.ADAPTATION	<sp>(START,STOP,SLOW,FAST,CANCEL,0,1)<cr><lf>	Starts or stops controller adaption routine. Note: There is no difference between slow and fast. Both start the same controller adaptation process, and are only for backwards compatibility.
NVR.ADAPTATION.CONFIG? <n>		Returns index, name, and status at index n. Status can be ERROR (no file), INVALID (file exists but bad data), VALID (valid file), or ACTIVE
NVR.ADAPTATION.CONFIG.ACTIVE?		Returns index of active regulator configuration (1..8, or Factory)
NVR.ADAPTATION.CONFIG.NAME <n>,<s>		Set name of regulator configuration at index n (1..8) to string s. S may contains alpha or numeric characters or %-_.<sp>
NVR.ADAPTATION.CONFIG.NAME? <n>		Returns name of regulator configuration at index n (1..8)
NVR.ADAPTATION.CONFIG.LOAD <n>		Load regulator configuration from file <n> to regulator board and set as active, where <n> is 1..8 or factory
NVR.ADAPTATION.CONFIG.SAVE <n>		Save regulator board's current configuration to file at index <n> and set file <n> as active

PN 0018708001J 03 / 2024 EN

7. Remote Operation

EN

NVR.ADAPTATION?	<sp>0to -6<cr><lf>	Returns status of controller adaption routine where the response is: 0, OK -1, active -2, leakage or no pressure supply -3, pressure supply too high or wrong mode -4, default during controller adaption -5, calculation fault -6, abandoned process
OSVERSION?	<sp>n.n<cr><lf>	Returns the operating system version.
Outform	1 to 7 – see table below	Sets the output format
Outform?	<sp>X<cr><lf>	Returns the output format
Overrange		Set the overrange percentage
Overrange?	<sp>+n.nnnnnE+nn<cr><lf>	Get the overrange percentage
Peakmax?	<sp>n.nnnnnE+nn<cr><lf>	Returns the maximum pressure since peakreset was sent.
Peakmin?	<sp>n.nnnnnE+nn<cr><lf>	Returns the minimum pressure since peakreset was sent.
Peakreset	None	Resets the peak values.
PILOT?	<sp>+n.nnnnnE+nn<cr><lf>	Returns the pilot sensor (sensor 3) pressure reading
Port	nnnnnn	Sets the Ethernet port of the instrument
Port?	<sp>nnnnn<cr><lf>	Returns the Ethernet port of the instrument
Ptype	Absolute or Gauge	Sets the instrument pressure type. Emulation only works if the optional barometric transducer is installed.
Ptype?	<sp>CCCC<cr><lf>	Returns “ABSOLUTE”, “GAUGE”, “ABSOLUTE EMULATION”, “GAUGE EMAULTION”, or “DIFFERENTIAL” for the active pressure type
Range?	<sp>+n.nnnnnE+nn<cr><lf>	Alias for “RangeMax?”. See RangeMax?
RangeMax?	<sp>+n.nnnnnE+nn<cr><lf>	Returns the maximum range of the active transducer in the current units.
RangeMin?	<sp>+n.nnnnnE+nn<cr><lf>	Returns the minimum range of the active transducer in the current units.
Rate?	<sp>+n.nnnnnE+nn<cr><lf>	Returns the rate reading of the instrument in current units/current time unit. See Runits.
Rdecpt?	<sp>n<cr><lf>	Returns the number of rate decimal points. See Resolution

PN 0018708001J 03 / 2024 EN

7. Remote Operation

EN

Reference	{EXTVAC or ATM}	Sets the reference type for vacuum pump connected to the reference, or vented to atmosphere. This option is available only on native gauge units.
Reference?	<sp>{EXTVAC or ATM}<cr><lf>	Returns the current reference type. See: Reference
Relaybd_version?	<sp>cccccccc<cr><lf>	Returns the relay board firmware version
Release?	15 char string. Ex: Release? Test_stand_1 Returns: <sp>(YES or NO), CCC...CCC<cr><lf>	This command is used to release control of the instrument in a multiple computer environment. Yes if release is successful No if instrument is being controlled with another computer CCC... = name of controlling computer or AVAILABLE See: Acquire? and Unlock
RESET_INSTRUMENT_TIME_ON		Reset the "instrument time on" counter to 0.
RESET_INSTRUMENT_CONTROL_TIME_ON		Reset the "instrument control time on" counter to 0.
Resolution	<n>	Sets the number of significant digits. See decpt
Resolution?	<sp>n<cr><lf>	Returns the number of significant digits. See decpt
Rfilter	Value in %	Sets the % of the rate filter.
Rfilter?	<sp>+n.nnnnnE+nn<cr><lf>	Returns the rate filter.
RFilterWin	nnn	Set the rate filter window as a floating point value in pressure
RFilterWin?	<sp>+n.nnnnnE+nn<cr><lf>	Returns the rate filter window
RLLIMIT	nnn	Alias for "RLowerLimit". SeeRLowerLimit
RLLIMIT?	<sp>+n.nnnnnE+nn<cr><lf>	Alias for "RLowerLimit?". SeeRLowerLimit?
RLowerLimit	nnn	Set the rate lower control limit
RLowerLimit?	<sp>n.nnnnnE+nn<cr><lf>	Alias for "RLowerLimit?". SeeRLowerLimit?
Rsetpt	Value in current units	Sets the rate setpoint
Rsetpt?	<sp>n.nnnnnE+nn<cr><lf>	Returns the rate setpoint
RStable?	YES or NO	
RStableTime	0 to 65535	Sets the rate stable time to the number of seconds specified

7. Remote Operation

RStableTime?	<sp>XXXXXXX<cr><lf>	Returns the rate stable time
RStableWin	nnn	Alias for “RStableWindow”. See RStableWindow
RStableWin?	<sp>+n.nnnnnE+nn<cr><lf>	Alias for “RStableWindow?”. See RStableWindow?
RStableWindow	nnn	Set the rate stable window as a %FS/second
RStableWindow?	<sp>+n.nnnnnE+nn<cr><lf>	Returns the rate stable window
RULIMIT	nnn	Alias for “RUpperLimit”. See RUpperLimit
RULIMIT?	<sp>+n.nnnnnE+nn<cr><lf>	Alias for “RUpperLimit?”. See RUpperLimit?
Runits	Sec, min, hr	Sets the rate time unit.
Runits?	<sp>XXXX<cr><lf>	Returns the rate time unit.
RUpperLimit	nnn	Set the rate upper control limit
RUpperLimit?	<sp>n.nnnnnE+nn<cr><lf>	Returns the rate upper control limit
Rwindow	Value in current units	Sets rate exponential filter window
Rwindow?	<sp>n.nnnnnE+nn<cr><lf>	Returns rate exponential filter window
Save_cal		Save calibration values
Sbaud	9600, 19200, 38400, 57600, 115200	Sets the serial baud rate.
Sbaud?	<sp>XXXX<cr><lf>	Returns the serial baud data.
Sdata	7 or 8	Sets the serial data bits.
Sdata?	<sp>n<cr><lf>	Returns the serial data bits number.
Sensor	1, 2, 3, or PRIMARY, SECONDARY, TERTIARY	Sets the active transducer.
Sensor?	<sp>XXXXXXXX,1<cr><lf>	Returns active transducer in long string format.
Sensor3?	<sp>n.nnnnnE+nn<cr><lf>	Only valid for CPC8000H. Returns the pilot sensor (sensor 3) pressure reading in current engineering units. Alias to “Pilot?”
Sensorid?	<sp><sen- sor#><sp>ID<sp>MEN- SOR,<sp><mod- el>,<sp><SN>,<sp>V<ver- sion><cr><lf>	Returns the active transducer’s serial number and firmware version.
Sensorsn?	<sp><Sen- sor#><sp>ID<sp>MEN- SOR,<sp><MOD- EL>,<sp><SN>,<sp>V<ver- sion><cr><lf>	Returns the active sensor’s ID string, which includes its address, manufacturer(Mensor), Model (i.e. 8K_XDCR), and version (i.e. 4.00)
Setpoint	nnn.nnn	Sets the control setpoint for the instrument. Value must be inside upper and lower limits. Alias for “Setpt”
Setpoint?	<sp>nnn.nnnE+nn<cr><lf>	Returns the control setpoint in current units

EN

PN 0018708001J 03 / 2024 EN

7. Remote Operation

EN

Setpoint%	nnn.nnn	Sets the control setpoint in %FS of primary transducer range
Setpoint%?	<sp>nnn.nnnnE+nn<cr><lf>	Returns the current setpoint in % of primary transducer range. Alias for "Setpt%?"
Setpt	nnn.nnn	Sets the control setpoint for the instrument. Value must be inside upper and lower limits
Setpt?	<sp>+n.nnnnnE+nn<cr><lf>	Returns the control setpoint in current units.
Setptpct	nnn.nnn	Sets the control setpoint in % of current range.
Setptpct?	<sp>+n.nnnnnE+nn<cr><lf>	Returns the current setpoint in % of current range.
Span	nnn.nnn (Desired pressure value)	Sets span on active transducer or for ?, clears previous value, must be > 50% FS and has a 1% limit. CALDISABLE must be OFF/NO.
Span?	<sp>+n.nnnnnE+nn<cr><lf>	Returns span scale factor for active transducer.
Sparity	Even, ODD, NONE	Sets the serial parity.
Sparity?	<sp>CCCC<cr><lf>	Returns the serial parity.
Srqmask	Stable,Error or both	Sets the CPC8000-H to issue a service request (SRQ) over the IEEE when the pressure control is stable, or an error occurs. These are 80 hex and 40 hex respectively.
Srqmask?	<sp>{string}<cr><lf>	Returns "stable", "error" or "error, stable" depending on the SRQ.
Sstop	1 or 2	Sets the serial stop bits.
Sstop?	<sp>X<cr><lf>	Returns the serial stop bits.
Stable?		Returns YES if instrument is stable, or NO.
Stabledelay	0 to 65535	Sets the stable time to the number of seconds specified.
Stabledelay?	<sp>XXXXXX<cr><lf>	Returns the stable time.
Stabletime	0 to 65535	Sets the stable time to the number of seconds specified.
Stabletime?	<sp>+n.nnnnnE+nn<cr><lf>	Returns the stable time.
StableWin	nnn.nnn	Sets the stable window as a %FS of active transducer
StableWin?	<sp>+n.nnnnnE+nn<cr><lf>	Returns the stable window.
Standby	None	Instrument placed in Standby mode
Standby?	<sp>(YES or NO)<cr><lf>	Returns YES if instrument is in Standby, NO if otherwise
Step	Value inside upper and lower limits and inside the range of the active transducer	Sets the control step size for the instrument
Step-		Jogs the setpoint down one step

PN 0018708001J 03 / 2024 EN

7. Remote Operation

EN

Step+		Jogs the setpoint up one step
Step?	<sp>+n.nnnnnE+nn<cr><lf>	Returns the control step for the instrument
Step%	Value in % of current range	Sets the control step in % of current range
Steppct	Value in % of current range	Sets the control step in % of current range
Steppct?	<sp>+n.nnnnnE+nn<cr><lf>	Returns the current step in % of current range
Subunits	units code or text in table below	Sets engineering units in Auxiliary Display 1. See units text in Section 11.4
Subunits?	<sp>CCCC<cr><lf>	Returns the instrument sub units in a text string
Tare	ON or OFF	Tares current reading to zero. The same tare value is applied to all measuring transducers.
Tare?	<sp>+n.nnnnnE+nn<cr><lf>	Returns the tare value applied to all transducers in current units.
Termchar	CCC	Set the termination character for the active command set (for example the Mensor command set will be different from the SCPI command set). Accepts the following: CRLF, CR, LF, EOI, NONE, DEFAULT
Termchar?	<sp>CCCC<cr><lf>	Returns the termination character.
Timeouten	ON or OFF	Enables the Ethernet timeout
Timeouten?	<sp>(YES or NO)<cr><lf>	Returns the Ethernet timeout state
Timeoutsec	nnn	Set the Ethernet timeout in seconds, to automatically close the socket if no activity has occurred. The default is 172800 seconds (2 days).
Timeoutsec?	<sp>nnnnnnn<cr><lf>	Returns the Ethernet timeout in seconds
Touchcal		Start the touchscreen calibration process
Truepress?<sp><n>	<sp>+n.nnnnnE+nn<cr><lf>	Returns the reference pressure for the specified segment n
Truepress<sp><n>,<f>	Number which must be between the values of segment n-1 and n+1. End points must be within 1% of the minimum and maximum of the range's span.	Used for a linearity calibration fix. Sets the reference pressure for segment n. N is 0 to 9. See "Calculate_as_found_linearity"
ULimit	nnn	Alias for "Upperlimit". See Lowerlimit
ULimit?	<sp>xxxxxx<cr><lf>	Alias for "Upperlimit?". See Lowerlimit
UNCERTAINTY?	<sp>+n.nnnnnE+nn<cr><lf>	Returns the current uncertainty of the pressure reading in the active pressure units based on the accuracy of the sensor and the current pressure reading.

PN 0018708001J 03 / 2024 EN

7. Remote Operation

EN

Units	See units code or text in Section 11.4	Sets the instrument engineering units. .
Units?	<sp>CCCC<cr><lf>	Returns the instrument units in a text string
Unitbase1	See units code or text in Section 11.4	Sets the user 1 base engineering units. Options are psi, bar, pascal.
Unitbase1?	<sp>CCCC<cr><lf>	Returns the user 1 base units in a text string
Unitbase2	See units code or text in Section 11.4	Sets the user 2 base engineering units. Options are psi, bar, pascal.
Unitbase2?	<sp>CCCC<cr><lf>	Returns the user 2 base units in a text string
Unitfact1	Multiplier factor	Sets the user 1 unit multiplier
Unitfact1?	<sp>n.nnnnnE+nn<cr><lf>	Returns the user 1 unit multiplier
Unitfact2	Multiplier factor	Sets the user 2 unit multiplier
Unitfact2?	<sp>n.nnnnnE+nn<cr><lf>	Returns the user 2 unit multiplier
ULimit	nnn	Alias for “Upperlimit”. See Upperlimit
ULimit?	<sp>xxxxxxx<cr><lf>	Alias for “Upperlimit?”. See Upperlimit?
Unlock	None	Releases Acquire locks See Acquire? And Release?
UpperLimit	nnn	Sets the upper control limit for the active transducer.
UpperLimit?	<sp>+n.nnnnnE+nn<cr><lf>	Returns the upper control limit for the active transducer.
Vent	None	Instrument placed in Vent Mode
Vent?	<sp>(YES or NO)<cr><lf>	Returns YES if instrument is in Vent, NO if otherwise
Vent_Limit	nnn	Set the pressure where the vent valve will open completely during a controlled vent
Vent_Limit?	<sp>+n.nnnnnE+nn<cr><lf>	Returns the vent limit in current units.
VENT_RATE	nnn	Set the controlled vent rate
VENT_RATE?	<sp>+n.nnnnnE+nn<cr>><lf>	Returns the controlled vent rate
WID?	<sp>SENSOR,WIKASN,X. XX.XX<cr><lf>	Returns manufacturer, instrument’s Wika serial number, instrument software version number
Window	Value in current units	Sets the exponential filter window for the active transducer
Window?	<sp>+n.nnnnnE+nn<cr><lf>	Returns the exponential filter window for the active transducer
Zero	desired pressure or ?	Sets zero to set pressure or for ?, clears previous value. CALDISABLE must be OFF/ NO.
Zero?	<sp>+n.nnnnnE+nn<cr><lf>	Returns zero offset for active transducer

PN 0018708001J 03 / 2024 EN

7. Remote Operation

7.7 Wika SCPI Command Set

The table 7.7 below lists the current SCPI commands and queries:

Table 7.7

Command or Query		Response/Function
MEASure		
	[:PRES sure] [R]?	Returns the pressure from range R.
	:TEMP erature[R]?	Returns the temperature from range R.
	:RATE[R]?	Returns the pressure rate/sec from range R.
	:BARO metric?	Returns the barometric pressure.
	:SLEW[R]?	See MEASure:RATE?
CALibration		
	[:PRESSure][R]	
	:MODE?	Returns 1=calibrated or 0=not calibrated.
	:DATE?	Returns date of cal "MM/DD/YY"
	:DATE <i,i,i>	Sets date of cal YYYY,MM,DD
	:ZERO?	Returns zero offset.
	:ZERO <n>	Sets the zero offset.
	:ZERO:RUN	Start autozero sequence.
	:ZERO:STOP	Stop autozero sequence
	:ZERO:INITiate?	Returns zero status
	:ZERO:INITiate	Ignored
SENSe		
	[:PRESSure] [R]	
	:NAME?	Returns transducer name string.
	:MODE?	Returns pressure type "ABSOLUTE" or "GAUGE"
	:MODE ABS GAUGE	Sets the pressure type to absolute or gauge.
	:ABS?	Returns native transducer type "1" for absolute, "0" for gauge.
	:RESolution?	Returns resolution (float).
	:RANGe	
	:UPPer?	Returns the maximum range.
	:LOWer?	Returns the minimum range.
	:Unit	
	:NAME?	Returns ASCII units (mixed case).
	:VALue?	Returns the units conversion factor.
	:REFerence	
	:HEIGHt] <n>	Sets the head pressure height.
	:HEIGHt?	Returns the head pressure height.
	:MODE?	Returns "OFF", "GAS", or LIQUID".

PN 0018708001J 03 / 2024 EN

7. Remote Operation

EN

		:MODE OFF GAS LIQUID	Sets the head pressure mode.
		:MEDium<n>	Sets the medium density.
		:MEDium?	Returns medium.
	:ACTive <n>		Sets the active transducer
	:ACTive?		Returns the active transducer
SYSTEM			
	:DATE <i,i,i>		Not used, kept for backwards compatibility
	:DATE?		Not used, does not cause an error, does not return a response.
	:TIME <i,i,i>		Not used, kept for backwards compatibility
	:TIME?		Not used, does not cause an error, does not return a response.
	:ERRor[:NEXT]?		Return error code, description.
	:KLOCK ON OFF 1 0		Sets the keylock state.
	:PRESet		Load default values.
	:SAVE		no function (not needed).
	:VERSion?		Return SCPI version 1994.0.
TEST			
	:ELECTronic?		Returns "OK".
	:RELay <n>?		Returns status of digital output <n>.
	:RELay <n> ON OFF		Turns the digital output on or off <n>.
UNIT			
	:NAME <n>?		(Note: see Table 11.1 Measurement Units) Returns the units string for units code <n>.
	:FACTor <n>?		Returns the units conversion for units code <n>.
	[:PRESsure] bar Imbar Palpsi		Sets the pressure units.
	[:PRESsure]?		Returns the pressure units.
	:USER		
		:FACTOR <n>, <f>	Sets the multiplier to <f> for user unit <n>
		:FACTOR ? <n>	Returns the multiplier <f> for user unit <n>
		:BASE <n>, <s>	Sets the base engineering units for user unit <n>, options are psi, bar, pascal.
		:BASE? <n>	Returns the base engineering units for user unit <n> as a text string
	:INDEX <n>		Sets the global remote unit by index number.

7. Remote Operation

EN

	:INDEX?	Returns the index number. <table border="1"> <thead> <tr> <th>Index</th> <th>Unit</th> </tr> </thead> <tbody> <tr><td>0</td><td>bar</td></tr> <tr><td>1</td><td>mbar</td></tr> <tr><td>2</td><td>Pa</td></tr> <tr><td>3</td><td>psi</td></tr> <tr><td>4</td><td>atm</td></tr> <tr><td>5</td><td>kp/cm²</td></tr> <tr><td>6</td><td>lbf/ft²</td></tr> <tr><td>7</td><td>kPa</td></tr> <tr><td>8</td><td>cmH₂O(4°C)</td></tr> <tr><td>9</td><td>inH₂O(4°C)</td></tr> <tr><td>10</td><td>inH₂O(20°C)</td></tr> <tr><td>11</td><td>inH₂O(60°F)</td></tr> <tr><td>12</td><td>ftH₂O(4°C)</td></tr> <tr><td>13</td><td>mmHg(0°C)</td></tr> <tr><td>14</td><td>cmHg(4°C)</td></tr> <tr><td>15</td><td>inHg(0°C)</td></tr> <tr><td>16</td><td>inHg(60°F)</td></tr> <tr><td>17</td><td>% of range</td></tr> <tr><td>18</td><td>user units 1</td></tr> <tr><td>19</td><td>user units 2</td></tr> </tbody> </table>	Index	Unit	0	bar	1	mbar	2	Pa	3	psi	4	atm	5	kp/cm ²	6	lbf/ft ²	7	kPa	8	cmH ₂ O(4°C)	9	inH ₂ O(4°C)	10	inH ₂ O(20°C)	11	inH ₂ O(60°F)	12	ftH ₂ O(4°C)	13	mmHg(0°C)	14	cmHg(4°C)	15	inHg(0°C)	16	inHg(60°F)	17	% of range	18	user units 1	19	user units 2
Index	Unit																																											
0	bar																																											
1	mbar																																											
2	Pa																																											
3	psi																																											
4	atm																																											
5	kp/cm ²																																											
6	lbf/ft ²																																											
7	kPa																																											
8	cmH ₂ O(4°C)																																											
9	inH ₂ O(4°C)																																											
10	inH ₂ O(20°C)																																											
11	inH ₂ O(60°F)																																											
12	ftH ₂ O(4°C)																																											
13	mmHg(0°C)																																											
14	cmHg(4°C)																																											
15	inHg(0°C)																																											
16	inHg(60°F)																																											
17	% of range																																											
18	user units 1																																											
19	user units 2																																											
OUTPUT																																												
	:STATe ON/OFF/1/0	ON or 1 = Control OFF or 0 = Measure.																																										
	:STATe?	Returns 0 for measure 1 for control.																																										
	:MODE MEASure/CONTRol/VENT	Sets the mode indicated.																																										
	:MODE?	Returns the mode string.																																										
	:STABle?	Returns 1 if stable 0 if not.																																										
	:AUTOvent ON/OFF/1/0	Autovent causes the controller to vent when a setpt of 0 is sent while in gauge or gauge emulation.																																										
	:AUTOvent?	Returns the autovent state.																																										
SOURCE																																												
	[[:PRESsure]																																											
	[[:LEVel]																																											
	[[:IMMediate]																																											
	[[:AMPLitude] <n>	Sets the setpoint.																																										
	[[:AMPLitude]?	Returns the setpoint.																																										
	:SLEW <n>	Sets the slew rate setpoint in %FS/sec.																																										
	:SLEW?	Returns the slew rate setpoint.																																										
	:TOLerance <n>	Sets the stable window in %FS.																																										
	:TOLerance?	Returns the stable window in %FS.																																										
CALCulate																																												
	:LIMit																																											
	:LOWer<n>	Sets minimum control limit.																																										
	:LOWer?	Returns minimum control limit.																																										
	:UPPer<n>	Sets maximum control limit.																																										
	:UPPer?	Returns maximum control limit.																																										

PN 0018708001J 03 / 2024 EN

7. Remote Operation

EN

		:VENT <n>	Pressure at which the vent solenoid opens for an uncontrolled vent.
		:VENT?	Returns the pressure at which the vent solenoid opens.
		:VRATE	Sets the rate at which the controlled vent goes to atmosphere.
		:VRATE?	Returns the rate at which the controlled vent goes to atmosphere.
	:SYSTem		
		:DETECT SLOW/FAST/CANCEL	Starts or stops controller adaption routine. Note: There is no difference between slow and fast. Both start the same controller adaptation process, and are only for backwards compatibility.
		:DETECT?	Returns status of controller adaption routine where the response is: 0, OK -1, active -2, leakage or no pressure supply -3, pressure supply too high or wrong mode -4, default during controller adaption -5, calculation fault -6, abandoned process
	:TARE		
		:STATe ON/OFF/1/0	Tare the current reading. The same tare value is applied to all measuring transducers.
		:STATe?	Returns the tare value.

8. Maintenance and Recalibration

8. Maintenance and Recalibration

EN



For contact details, please see chapter 1 “General information” or the back page of the operating instructions.

8.1 Maintenance

The CPC8000-H was designed for maintenance-free operation. User maintenance is not recommended, beyond replacement of media and transducer removal at calibration intervals. The media should be replaced every 2 years to prevent damage to the internal seals. If you have questions not covered by this manual, call 1-800-984-4200 (USA only), or 1-512-396-4200 for assistance, or send an email to tech.support@mentor.com.

8.1.1 Beyond the Warranty

Take advantage of Mensor’s expert product care. Mensor provides complete maintenance and calibration services, available for a nominal fee. Our service staff is knowledgeable in the innermost details of all of our instruments. We maintain units that are in operation in many different industries and in a variety of applications, and by users with a wide range of requirements. Many of these instruments have been in service for years, and continue to produce excellent results. Returning your instrument to Mensor for service benefits you in several ways:

- Our extensive knowledge of the instrument assures you that it will receive expert care.
- In many cases we can economically upgrade an older instrument to the latest improvements.
- Servicing our own instruments which are used in “real world” applications keeps us informed as to the most frequent services required. We use this knowledge in our continuing effort to design better and more robust instruments.
- Repair or replacement of the CPC8000-H chassis, hydraulic module and measurement transducers will be available up to 7 years after the production life cycle of the product, pending external vendor parts or equivalent parts availability. The production life cycle is defined as the time from the product series launch to the announcement of discontinuation (typically 8 to 10 years).
- All repairs associated with the chassis or internal modules should be performed by Mensor due to the complexity of performing these repairs. Replacement of measurement transducers and media refill can be done at the customer’s site.

8.1.2 Hydraulic Media Filling

The rear panel of the CPC8000-HM provides a filling nozzle for the hydraulic media in the upper right corner of the hydraulic module. The fill requirements can be seen on the rear panel through a media level window that shows the minimum and maximum levels of fluid. If the reservoir is empty, the instrument needs ~2 liters of fluid to refill itself. Any external connections should be prefilled with fluid before connecting to the CPC8000-H.



WARNING!

Air contaminated media will affect functionality. During the filling process, it is recommended that the external connections be free of any air molecules to prevent longer pump times and compressibility.



WARNING!

Do not overfill the media reservoir!

Filling nozzle is connected to the media reservoir. This tank can leak if the reservoir is overfilled or tilted. If an external reservoir is used, stabilize the reservoir on a flat surface.



Figure 8.2.2 Rear Panel



Always use the media that is labeled on the instrument, never mix media.

8.1.3 Transducer Removal

All transducers within the CPC8000-H can be removed and replaced. The following instructions are to be used when removing or replacing any of these sensors.



CAUTION! The instrument must be completely vented, removed from the pressure source, and the power to the instrument must be switched off before beginning the transducer removal or replacement.

• CPC8000-HC Pneumatic Controller

1. Vent the system by placing the instrument in Vent mode. Then turn off the power.
2. Loosen the Philips screws that secure the door closed. These are captive screws, so they will not become detached from the front panel.
3. With the door open, you will see the pilot pneumatic transducer and an optional barometric reference. Remove the ribbon cable from each of these sensors by grabbing the connector and lightly pulling it off the transducer port.
4. Use a 3/16" hex key to remove the two black bolts that hold the pilot sensor in place. There are two O-rings located between the sensor and the manifold. Ensure that these O-rings remain attached to the manifold within the CPC8000-HC. Remove the optional barometric reference transducer with the thumb screw. If the screw is too tight to remove by hand, a small slotted screwdriver may be used.
5. To replace or reinstall these transducers, install each in the reverse order as the removal process.

8. Maintenance and Recalibration

EN

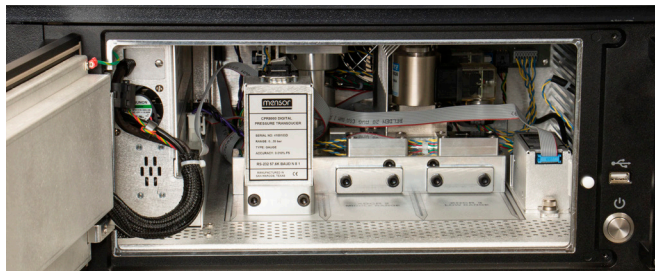
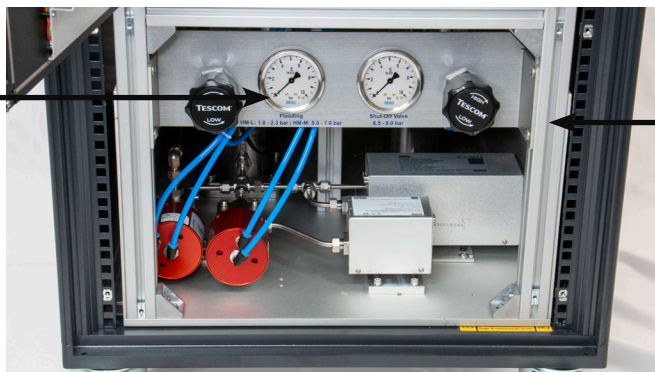

Figure 8.2.3-A CPC8000-HC Front View

• CPC8000-HM Hydraulic Module

1. Vent the system by placing the controller in Vent mode. Then turn off the power.
2. Beginning with the 4 inner screws, remove all 8 screws from the front panel of the CPC8000-HM with a 4mm hex tool.
3. Once the screws are removed, the black panel will be free and can be removed. With the panel removed there will be either 1 or 2 transducers visible.
4. Remove the ribbon cable from the transducer(s) by grabbing the connector and lightly pulling away from the transducer.
5. For cleanliness, use a paper towel or rag and place it beneath the transducer pressure connection.
6. Using two wrenches, place one on the transducer fitting and the other on the tube fitting to loosen the pressure port connection. Fluid will drip from this port as the fitting is loosened.
7. Remove the two cap screws that hold the transducer to the baseplate using a 3mm hex drive wrench.
8. If a second sensor is installed, follow steps 5-7 for removal.
9. To replace or reinstall these transducers, install each in the reverse order as the removal process.

Pilot Transducer



Optional Barometric Reference

Figure 8.2.3-B CPC8000-HM-M Front View

WARNING!



Check for leaks after all transducer replacements and reinstallations. Properly mount and tighten the fitting before applying pressure to the CPC8000-H.

8.2 Recalibration

The CPC8000-H automatically adjusts the pressure reading for the effects of temperature and non-linearity within the calibrated temperature range of 15-45C. The process is referred to as dynamic compensation because each reading is adjusted before it is output to the display or to a communication bus. Thus, a calibrated CPC8000-H operated within its temperature band, and with proper zero and span adjustments, will provide accurate pressure measurements.

PN 0018708001J 03 / 2024 EN

8. Maintenance and Recalibration

The CPC8000-H should have the calibration verified periodically to ensure stability. The recommended calibration interval for this instrument is given in the Specifications section under "Calibration Interval" in Section 10.1.



WARNING!

Performing calibration on components within the CPC8000-H could alter the accuracy of the complete instrument!

EN

8.2.1 Calibration Services by Mensor or WIKA Worldwide

Mensor and WIKA worldwide have extensive experience and knowledge of Mensor products. Calibration of the transducers in these products can be performed at the addresses below or by competent internal or external labs using the procedures in this section

Service Center USA	Service Center Europe
Mensor website: www.mensor.com tel: 1-512-396-4200 1-800-984-4200 fax: 1-512-396-1820 email: tech.support@mensor.com	WIKA Alexander Wiegand SE & Co. KG website: www.wika.de / www.wika.com tel: (+49) 9372 132-5049 email: CTServiceTeam@wika.com
Service Center China	WIKI Instrumentation PTE. LTD.
WIKI China website: www.wika.cn contact: Eric Wang tel: (+86) 512 6878 8000 fax: (+86) 512 6809 2321 email: eric.wang2@wika.com	13 Kian Teck Crescent 628878 Singapore Tel: +65 6844 5506 E-mail: info@wika.sg

8.2.2 Environment

For maximum accuracy, allow the CPC8000-H to warm up a minimum of 15 minutes in ambient temperature within the compensated temperature range prior to a calibration. In addition, the instrument should be at rest on a stable platform that is free of excess vibration and shock.

8.2.3 Pressure Standards

Mensor recommends the use of appropriately accurate primary pressure standards when calibrating this instrument. Such standards should be sufficient so that when the techniques of the ISO Guide of the Expression of Uncertainty in Measurement (GUM) are applied, the instrument meets its accuracy statements as required by ISO/IEC 17025:2017, or other applicable standards.

8.2.4 Media

The recommended calibration medium for the primary and secondary transducers is the same media that is on the label of the CPC8000-HM hydraulic module. The recommended calibration medium for the optional barometric reference transducer is dry nitrogen or clean dry air. A height variation between the standard and the CPC8000-H can cause errors. A calculation should be made to compensate for this difference. This compensation can be done following the instructions from Section 9.10 Head Pressure. It is recommended to use the calibrating device to calculate the height correction rather than the CPC8000-H when calibrating the internal sensors.

8. Maintenance and Recalibration

8.2.5 Setup

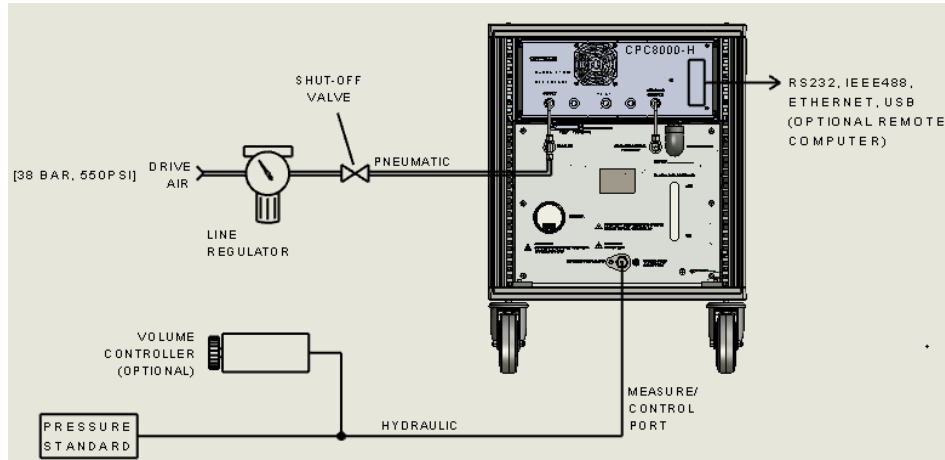

8.2.6 Calibration data

The calibration data information for each transducer is stored under the "Info" tab in the 1 point, 2 point, or linearize calibration application (Figure 8.3.6 Calibration Data). The serial number (S/N), range, units, pressure type, accuracy, calibration date, zero offset (Zero), span offset (Span), calibration interval and transducer software version can be seen on this screen. These values will show all the current settings that are active on all transducers installed.

Sensor Information				
	Primary	Secondary	Tertiary	Barometer
Serial Number	939035	41000J72	41000IN3	41000KEW
Max	23015.0	10015.0	35.0000	17.0000
Min	0.0	0.0	0.0000	8.0000
Units	PSI	PSI	BAR	PSI
Type	A	A	G	A
Accuracy	0.014% IS-33	0.010% FS	0.010% FS	0.010% R
Certificate				
Date of Calibration	09/20/2019	08/19/2019	01/01/2000	08/15/2019
Zero	0.00	-0.27	0.00000	0.00000
Span	1.00	1.00	1.00000	1.00000
Interval	365	365	365	365
Version	1.04	5.00	5.00	1.07

Figure 8.2.6 Calibration Data

9. Dismounting, Return and Disposal

9. Dismounting, Return and Disposal



WARNING!

Physical injuries and damage to property and the environment through residual media

Residual media in the dismantled instrument can result in a risk to persons, the environment and equipment.

- ▶ Wear the requisite protective equipment (see Section 3.6 Personal Protective Equipment).
- ▶ Observe the information in the material safety data sheet for the corresponding medium.
- ▶ Wash or clean the dismantled instrument, in order to protect persons and the environment from exposure to residual media.

EN

9.1 Dismounting



WARNING!

Physical injuries and damage to property and the environment through residual media

Upon contact with hazardous media (e.g. oxygen, acetylene, flammable or toxic substances), harmful media (e.g. corrosive, toxic, carcinogenic, radioactive), and also with refrigeration plants and compressors, there is a danger of physical injuries and damage to property and the environment.

- ▶ Before storage of the dismantled instrument (following use) wash or clean it, in order to protect persons and the environment from exposure to residual media.
- ▶ Wear the requisite protective equipment (see Section 3.6 Personal Protective Equipment).
- ▶ Observe the information in the material safety data sheet for the corresponding medium.



WARNING!

Risk of burns

During dismantling there is a risk of dangerously hot media escaping.

- ▶ Let the instrument cool down sufficiently before dismantling it!



DANGER!

Danger to life caused by electric current

Upon contact with live parts, there is a direct danger to life.

- ▶ The dismantling of the instrument may only be carried out by skilled personnel.



WARNING!

Physical injury

When dismantling, there is a danger from aggressive media and high pressures.

- ▶ Wear the requisite protective equipment (see Section 3.6 Personal Protective Equipment).
- ▶ Observe the information in the material safety data sheet for the corresponding medium.
- ▶ Only disconnect the pressure measuring instrument/measuring assembly/test and calibration installations once the system has been depressurized.

9. Dismounting, Return and Disposal

9.2 Return

Strictly observe the following when shipping the instrument:

All instruments delivered to Mensor must be free from any kind of hazardous substances (acids, bases, solutions, etc.) must therefore be cleaned before being returned.

EN



WARNING!

Physical injuries and damage to property and the environment through residual media

Residual media in the dismantled instrument can result in a risk to persons, the environment and equipment.

- ▶ With hazardous substances, include the material safety data sheet for the corresponding medium..

When returning the instrument, use the original packaging or a suitable transport packaging.

To avoid damage:

1. Wrap the instrument in an anti static plastic film.
2. Place the instrument in the same packaging as it arrived. See Section 4. Transport, Packaging and Storage for details.
3. Label the shipment/ carrying case as carriage of a highly sensitive measuring instrument.



Information on returns can be found under the heading “Service” on our local website.

9.3 Disposal

Incorrect disposal can put the environment at risk.

Dispose of instrument components and packaging materials in an environmentally compatible way and in accordance with the country-specific waste disposal regulations.



This marking on the instruments indicates that they must not be disposed of in domestic waste. The disposal is carried out by return to the manufacturer or by the corresponding municipal authorities.

10. Specifications

10. Specifications

Accuracy specifications presented herein are obtained by comparison with primary standards traceable to a national metrology institute or recognized international standard organization. These specifications are obtained in accordance with the ISO Guide to the Expression of Uncertainty in Measurement (GUM). The calibration program at Mensor is accredited by the American Association of Laboratory Accreditation (A2LA) as complying with both the ISO/IEC 17025:2017 and the ANSI/NCSL Z540-1-1994 standards. If there is an exception to the requirements and recommendations of Z540 during a calibration the exception is noted on the individual calibration certificate. Mensor reserves the right to change specifications without notice.

PN 0018708001J 03 / 2024 EN

10. Specifications

Reference pressure sensors

Model CPR8000	
Accuracy ¹⁾	0.008 % FS up to 0.008% IS-33
Pressure ranges	0...100 bar (0...1,500 psi) up to 0...400 bar (0...6,000 psi)
Precision ²⁾	0.004 % FS
Model CPR8050	
Accuracy ¹⁾	0.01 % FS
Pressure ranges	0...400 bar (0...6,000 psi) to 0 ... 700 bar (0 ... 10,000 psi)
Precision ²⁾	0.005% FS
Model CPR8850	
	Standard
Accuracy ¹⁾	0.014 % FS
Pressure ranges	0 ... 700 bar to 0 ... 1,600 bar (0 ... 10,000 psi to 0 ... 23,000 psi)
Precision ²⁾	0.007 % FS

1) The accuracy is defined by the total measurement uncertainty, which is expressed with the coverage factor (k = 2) and includes the following factors: the intrinsic performance of the measuring instrument, the measurement uncertainty of the reference instrument, long-term stability, influence of ambient conditions, drift and temperature effects over the compensated range during a periodic zero point adjustment.

2) The precision is the maximum deviation between two measurements at one point under laboratory conditions which contains linearity, hysteresis and repeatability of the measuring instrument.

Hydraulic module

Version	CPC8000-HM-L	CPC8000-HM-M
Instrument version	Standard: 19" rack-mounting with side panels incl. rack-mounting kit Optional: built into a 19" rack with CPC8000-HC pressure controller	
Dimensions in mm	see technical drawings	
Weight	approx. 78 kg (172 lb.)	approx. 87.5 kg (193 lbs.)
Connections		
Pressure connections	Drive-Air port: 6 mm FITOK®/SWAGELOK® tube connection Supply port: 6 mm FITOK®/SWAGELOK® tube connection Measure/Control port: 9/16-18 UNF.	Drive-Air port: 6 mm FITOK®/SWAGELOK® tube connection Supply port: 6 mm FITOK®/SWAGELOK® tube connection Measure/Control port: 9/16-18 UNF .
Permissible pressure media	Drive-Air port: clean and dry air or nitrogen Supply port: clean and dry air or nitrogen Measure/Control port: non-corrosive liquids (sebacate, shell tellur, distilled water, others upon request)	
Primary transducer model	CPR8050	CPR8850
Primary maximum range	700 bar (10,000 psi)	1600 bar (23,000 psi)
Primary minimum range	400 bar (6,000 psi)	1000 bar (15,000 psi)
Secondary transducer model	CPR8050 / CPR8000	CPR8050
Secondary minimum range	100 bar (1,500 psi)	400 bar (6,000 psi)
Permissible pressure		
Drive-Air port (from CPC8000-HC)	0 ... 35 bar (507 psi)	0 ... 35 bar (507 psi)
Supply port	35 (507 psi)	
Measure/Control port	max. 105 % FS	

EN

10. Specifications

Hydraulic module

Control parameters

Control stability ³⁾	< 0.005 % FS	
Control range	5 ... 700 bar (75 ... 10,000 psi)	20 ... 1,600 bar (290 ... 23,000 psi)

Permissible ambient conditions

Operating temperature	15 ... 40 °C (59 ... 104 °F)	
Storage temperature	5 ... 70 °C (41 ... 158 °F)	
Relative humidity	0 ... 95 % r.h. (non-condensing)	
Compensated temperature range	15 ... 40 °C (59 ... 104 °F)	
Mounting position	Horizontal	

³⁾ Based on the primary range of the instrument.

Pressure controller model CPC8000-HC

Instrument

Instrument version	Standard: 19" rack-mounting with side panels incl. rack-mounting kit Optional: built into a 19" rack with CPC8000-HM hydraulic module	
Warm-up time	approx. 60 minutes	
Dimensions in mm	see technical drawings	
Weight	approx. 16.7 kg (37 lbs.)	

Display

Screen	10.1" color TFT with touchscreen	
Resolution	4 ... 7 digits	
Input methods	capacitive touchscreen	

Connections

Pressure connections	7/16"-20 F SAE	
Pressure adapters	6 mm FITOK® threaded pipe connection; 1/4" tube adapter included	
Filter elements	all pressure ports have 40-micron filters	
Permissible pressure media	Dry, clean air or nitrogen	
Overpressure protection	Safety relief valve on reference transducer	

Permissible pressure

Drive Pressure	38.5 (558 psi)	
Measure/Control port	max. 105 % FS	

Voltage supply

Power supply	AC 100 ... 120 V / 200 ... 240 V, 50/60 Hz	
Power consumption	160 VA max	

Permissible ambient conditions

Operating temperature	15 ... 45 °C (59 ... 113 °F)	
Storage temperature	5 ... 70 °C (41 ... 158 °F)	
Relative humidity	0 ... 95 % r. h. (non-condensing)	
Compensated temperature range	15 ... 45 °C (59 ... 113 °F)	
Sensor Mounting position	Horizontal	







Communication

Interface	IEEE-488.2, Ethernet, USB, RS-232	
Command sets	Mensor, WIKA SCPI	
Response time	< 100 ms	

EN

10. Specifications



Approvals

Logo	Description	
	EC declaration of conformity <ul style="list-style-type: none"> ■ EMC directive 2014/30/EU ³⁾, EN 61326-1 emission (group 1, class A) and immunity (industrial application) ■ Low voltage directive 2014/35/EU, EN 61010-1 ■ RoHS directive 2011/65/EU 	European Community
	EAC <ul style="list-style-type: none"> ■ Electromagnetic compatibility ■ Low voltage directive 	Eurasian Economic Community
	GOST Metrology/measurement technology	Russia
	KazInMetr Metrology/measurement technology	Kazakhstan
	MTSCHS Commissioning approval	Kazakhstan
	BelGIM Metrology/measurement technology	Belarus
	UkrSEPRO Metrology/measurement technology	Ukraine
	Uzstandard Metrology/measurement technology	Uzbekistan

EN

3) **Warning!** This is class A equipment for emissions and is intended for use in industrial environments. In other environments, e.g. residential or commercial installations, it can interfere with other equipment under certain conditions. In such circumstances the operator is expected to take the appropriate measures.

Certificates

Approvals and Certificates		
Logo	Description	Country
	EU Declaration of Conformity EU Importer: WIKA, 63911 Klingenberg, Germany	European Union
	UKCA Declaration of Conformity Importer: WIKA Instruments Ltd, Unit 6 & 7 Goya Business Park, The Moor Road, Sevenoaks Kent, TN15 5GY	Great Britain
Certificates		
Calibration ¹¹⁾	Standard: A2LA accredited calibration certificate (standard on factory) Optional: DKD/DAkkS calibration certificate	

10) **Warning!** This is class A equipment for emissions and is intended for use in industrial environments. In other environments, e.g. residential or commercial installations, it can interfere with other equipment under certain conditions. In such circumstances the operator is expected to take the appropriate measures.

11) Calibration in a horizontal position/operating position.

Approvals and certificates, see website

11. Accessories

11. Accessories

- Barometric reference sensor (for pressure emulation)
- Barometric reference calibration sled
- CPR8000 reference pressure sensor calibration sled with power supply
- CPR8050/8850 reference pressure sensor calibration sled with power supply
- Operating fluid: Sebacate or Shell Tellus.

EN

11.1 Barometric Reference Sensor

The CPC8000-H can be ordered with an internal barometric reference sensor. It is a very stable, absolute pressure transducer, used to accurately measure local atmospheric pressure. It is used to display the barometric pressure (reading appears on the bottom right side of the display) or as a barometric reference for pressure emulation. The barometric reference sensor is installed inside the CPC8000-HC controller.

11.1.1 Emulation Mode Accuracy

The accuracy in emulation mode is different than native mode.

The barometric reference has six significant digits and has a guaranteed drift of 0.0000041 psi over a 24 hour period.

The absolute uncertainty of the barometric reference must be considered in the emulated pressure uncertainty.

11.1.2 Barometric Reference Calibration

The Barometric Reference Transducer can be calibrated in exactly the same manner as the other installed components as described in Section 8.2 Recalibration. Alternatively the barometric reference can be calibrated outside of the instrument using a calibration sled or adapter (Section 11.2 Barometric Reference Calibration Sled).

11.2 Barometric Reference Calibration Sled

The Barometric Reference Calibration Sled Kit is available to provide a way to calibrate the barometric reference remotely.

Calibration of the Barometric Reference can be performed remotely using the Cal sled, a PC and the software provided.



Figure 11.2 Barometric Reference Calibration Sled

11.3 Reference Pressure Calibration Sled

The CPC8000-H can be ordered with up to two internal reference pressure transducers. These are used to monitor pressure on the Measure/Control port. These transducers can use a calibration sled with power supply and software to perform calibrations at their required calibration interval.

PN 0018708001J 03 / 2024 EN

11. Accessories

11.3.1 CPR8000 Reference Calibration Sled

The CPR8000 Reference Calibration Sled Kit is available to provide a way to calibrate the reference pressure transducer remotely. Calibration of the CPR8000 can be performed remotely using the Cal sled, a PC and the software provided.

11.3.2 CPR8050 and CPR8850 reference pressure calibration sled

The CPR8050 and CPR8850 have a female 1/4-28UNF port that requires a cone and thread male fitting for pressure connection. The accessory kit for these transducers is a power supply combined with a serial communication device and a CD with the calibration software.

11.4 Operating fluid

The two factory available operating fluids for the CPC8000-H are Shell Tellus and Sebacate oil. If the CPC8000-H uses a different media, the user will need to purchase the additional media from an external source.

EN

12. Appendix

12. Appendix

12.1 Measurement Units

Table 12.1 Measurement Units (unitno)

EN

Code	Description	Output Format
1	pounds per square inch	psi
2	inches of mercury @ 0°C	in Hg 0°C
3	inches of mercury @ 60°F	in Hg 60°F
4	inches of water @ 4°C	in H2O 4°C
5	inches of water @ 20°C	in H2O 20°C
6	inches of water @ 60°F	in H2O 60°F
7	feet of water @ 4°C	ft H2O 4°C
8	feet of water @ 20°C	ft H2O 20°C
9	feet of water @ 60°F	ft H2O 60°F
10	millitorr	mTorr
11	inches of seawater @ 0°C 3.5% salinity	in SW
12	feet of seawater @ 0°C 3.5% salinity	ft SW
13	atmospheres	atm
14	bars	bar
15	millibars	mbar
16	millimeters of water @ 4°C	mm H2O 4°C
17	centimeters of water @ 4°C	cm H2O 4°C
18	meters of water @ 4°C	m H2O 4°C
19	millimeters of mercury @ 0°C	mm Hg 0°C
20	centimeters of mercury @ 0°C	cm Hg 0°C
21	torr	Torr
22	kilopascals	kPa
23	pascals	Pa
24	dyne per square centimeter	dyn/cm ²
25	grams per square centimeter	g/cm ²
26	kilograms per square centimeter	kg/cm ²
27	meters of seawater @ 0°C 3.5% salinity	m SW
28	ounce per square inch	osi
29	pounds per square foot	pfs
30	tons per square foot	tsf
31	percent of full scale	% of Range
32	micron of mercury @ 0°C	mHg
33	ton per square inch	tsi
34	meters of mercury @ 0°C	MHg
35	hectopascals	hPa
36	megapascals	MPa
37	millimeters of water @ 20°C	mm H2O 20°C
38	centimeter of water @ 20°C	cm H2O 20°C
39	meters of water @ 20°C	m H2O 20°C

12. Appendix

n/a	User Units 1	User defined
n/a	User Units 2	User defined

12.2 Conversion Factors, PSI

The values listed in the column "To convert from PSI" are the values imbedded in the instrument program. The values listed under "To convert to PSI" are internally calculated approximations based on the imbedded values.

Table 12.2 Conversion Factors, PSI

Code	Pressure Unit	To convert from PSI	To convert to PSI
1	PSI	1	1
2	inHg 0°C	2.036020	0.4911544
3	inHg 60°F	2.041772	0.4897707
4	inH2O 4°C	27.68067	0.03612629
5	inH2O 20°C	27.72977	0.03606233
6	inH2O 60°F	27.70759	0.03609119
7	ftH2O 4°C	2.306726	0.4335149
8	ftH2O 20°C	2.310814	0.4327480
9	ftH2O 60°F	2.308966	0.4330943
10	mTorr	51715.08	0.00001933672
11	inSW 0°C 3.5% salinity	26.92334	0.03714250
12	ftSW 0°C 3.5% salinity	2.243611	0.445710
13	ATM	0.06804596	14.69595
14	Bar	0.06894757	14.50377
15	mBar	68.94757	0.01450377
16	mmH2O 4°C	703.0890	0.001422295
17	cmH2O 4°C	70.30890	0.01422295
18	MH2O 4°C	0.7030890	1.422295
19	mmHg 0°C	51.71508	0.01933672
20	cmHg 0°C	5.171508	0.1933672
21	Torr	51.71508	0.01933672
22	kPa	6.894757	0.1450377
23	PA	6894.757	0.0001450377
24	Dy/cm2	68947.57	0.00001450377
25	gm/cm2	70.30697	0.01422334
26	kg/cm2	0.07030697	14.22334
27	MSW 0°C 3.5% salinity	0.6838528	1.462303
28	OSI	16	0.0625
29	PSF	144	0.006944444
30	TSF	0.072	13.88889
32	μHg 0°C	51715.08	0.00001933672
33	TSI	0.0005	2000
34	mHg 0°C	0.05171508	19.33672
35	hPa	68.94757	0.01450377
36	MPa	0.006894757	145.0377
37	mmH2O 20°C	704.336	0.001419777

PN 0018708001J 03 / 2024 EN

EN

12. Appendix

38	cmH ₂ O 20°C	70.4336	0.01419777
39	MH ₂ O 20°C	0.704336	1.419777

EN

WIKA subsidiaries worldwide can be found online at www.wika.com.



Mensor Corporation
201 Barnes Drive
San Marcos, TX 78666 • USA
Tel. (+1) 512 3964200-15
Fax (+1) 512 3961820
E-Mail sales@mensor.com
www.mensor.com



WIKA Alexander Wiegand SE & Co. KG
Alexander-Wiegand-Straße 30
63911 Klingenberg • Germany
Tel. +49 9372 132-0
Fax +49 9372 132-406
info@wika.de
www.wika.de

Imported to UK by:
WIKA Instruments Ltd,
Unit 6 & 7 Goya Business Park,
The Moor Road, Sevenoaks
Kent, TN15 5GY