

Portable Digital Pressure Gauge

CPG2300





Warning

This Warning symbol indicates that danger of injury for persons and the environment and/or considerable damage (mortal danger, danger of injury) will occur if the respective safety precautions are not taken.



Caution

This Caution symbol indicates danger for the system and material if the respective safety precautions are not taken.



Notice

This Notice symbol does not indicate safety notices but information for a better understanding of the facts.

Table of Contents

1. General Information	5
1.1 Warranty	5
1.2 Important Notice	5
1.3 Software License Agreement	6
1.4 Mensor Service Plus	6
1.4.1 After the Warranty	6
1.4.2 Calibration Services	6
1.4.3 Certifications and Accreditations	6
2. Safety Notices	7
2.1 Warnings and Caution Notices	7
3. Product Description	9
3.1 General Description	9
3.2 Display	9
3.3 Power Supply	9
3.4 Battery	9
3.5 Serial In/Out Communications	10
4. Specifications	11
5. Installation	13
5.1 Unpacking the Instrument	13
5.2 Dimensions	14
5.3 Pressure Connections	15
5.4 Electrical Connections	16
5.5 Power On	16
6. Local Operation	17
6.1 Keypad	17
6.2 Standard Display	18
6.3 Menu Screens	18
6.3.1 Main Menu Screen	18
6.3.2 Sensor Setup Menu	19
6.3.3 Password Entry Screen	21
6.3.4 Sensor Calibration Screen	21
6.3.5 Units Screens	23

Portable Digital Pressure Gauge CPG2300 Series

6.4 Menu Tree	24
7. Remote Operation	25
7.1 General	25
7.2 Communication Syntax and Command Conventions	25
7.2.1 Password Protection	26
7.2.2 Response String Format	26
7.2.3 Commands and Queries	27
7.2.4 User Programmable Pressure Units List	30
7.2.5 Pressure Unit Codes and Conversions	31
8. Options	33
8.1 Current Input	33
8.1.1 Menu Screens	33
8.1.2 Operational Notes	35
8.1.3 Connection Configurations	36
8.1.4 Application Diagrams	37
9. Calibration	39
9.1 Environment	39
9.2 Equipment	39
9.3 Pressure Standard	41
9.4 Calibration Medium	41
9.5 Calibration Process	41
9.5.1 Zero Adjustment	41
9.5.2 Span Adjustment	42

1. General Information

1.1 Warranty

All products manufactured by Mensor are warranted to be free of defects in workmanship and materials for a period of one year from the date of shipment. No other express warranty is given, and no affirmation of Seller, by words or actions, shall constitute a warranty. **SELLER DISCLAIMS ANY IMPLIED WARRANTIES OF MERCHANTABILITY OR FITNESS FOR ANY PARTICULAR PURPOSES WHATSOEVER.** If any defect in workmanship or material should develop under conditions of normal use and service within the warranty period, repairs will be made at no charge to the original purchaser, upon delivery of the product(s) to the factory, shipping charges prepaid. If inspection by Mensor or its authorized representative reveals that the product was damaged by accident, alteration, misuse, abuse, faulty installation or other causes beyond the control of Mensor, this warranty does not apply. The judgment of Mensor will be final as to all matters concerning condition of the product, the cause and nature of a defect, and the necessity or manner of repair. Service, repairs or disassembly of the product in any manner, performed without specific factory permission, voids this warranty.

MENSOR MAKES NO WARRANTY OF ANY KIND WITH REGARD TO THIS MANUAL, INCLUDING, BUT NOT LIMITED TO, THE IMPLIED WARRANTIES OF MERCHANTABILITY AND FITNESS FOR A PARTICULAR PURPOSE. Mensor shall not be liable for errors contained herein or for incidental or consequential damages in connection with the furnishing, performance, or use of this material.

1.2 Important Notice

The product specifications and other information contained in this manual are subject to change without notice.

Mensor has made a concerted effort to provide complete and current information for the proper use of the equipment. If there are questions regarding this manual or the proper use of the equipment, contact either Mensor or WIKA:

Mensor
201 Barnes Drive
San Marcos, Tx 78666
Tel: 1.512.396.4200
1.800.984.4200 (USA only)
Web Site: www.mensor.com
Fax: . 512.396.1820
E-Mail: sales@mensor.com
tech.support@mensor.com

WIKA Alexander Wiegand SE & Co. KG
Alexander-Wiegand-Straße 30
D-63911 Klingenberg / Germany
Tel: (+49) 93 72/132-9986
Web Site: www.wika.de
Fax: (+49) 93 72/132-8767
E-Mail: testequip@wika.de

Portable Digital Pressure Gauge CPG2300 Series

1.3 Software License Agreement

This product contains intellectual property, i.e., software programs, that are licensed for use by the end user/customer (hereinafter “end user”).

This is not a sale of such intellectual property.

The end user shall not copy, disassemble or reverse compile the software program.

The software programs are provided to the end user “as is” without warranty of any kind, either express or implied, including, but not limited to, warranties of merchantability and fitness for a particular purpose. The entire risk of the quality and performance of the software program is with the end user.

Mensor and its suppliers shall not be held to any liability for any damages suffered or incurred by the end user (including, but not limited to, general, special, consequential or incidental damages including damages for loss of business profits, business interruption, loss of business information and the like), arising from or in connection with the delivery, use or performance of the software program.

1.4 Mensor Service Plus

If you have problems and you don't find the answer in this manual, contact Mensor at 1.800.984.4200 (USA only) or 1.512.396.4200 for personal assistance, or at any of the contact addresses listed on the rear cover of this manual. We are ready to help.

1.4.1 After the Warranty

Mensor's concern with the performance of this instrument is not limited to the warranty period. We provide complete repair, calibration and certification services after the warranty for a nominal fee.

1.4.2 Calibration Services

In addition to servicing our own products Mensor can perform a complete pressure calibration service, up to 20,000 psi, for all of your pressure instruments. This service includes an accredited calibration.

1.4.3 Certifications and Accreditations

Mensor is registered to ISO 9001:2008. The calibration program at Mensor is accredited by A2LA, as complying with both the ISO/IEC 17025:2005 and the ANSI/NC SL Z540-1-1994 standards.

2. Safety Notices

2.1 Warnings and Caution Notices



Warning

WARNING: NOT EXPLOSION PROOF!
Installation of this instrument in an area requiring devices rated as intrinsically safe is not recommended.



Warning

WARNING: INJURY THROUGH IMPROPER USE! Do not use the instrument with materials and mixtures of the group 1 (hazardous fluids) according Regulation (EC) no. 1272/2008.



Caution

CAUTION: Some ranges require clean, non-corrosive pressure media. See “Media Compatibility” in Section 4, Specifications. This instrument is not designed for oxygen use.



Caution

CAUTION: Avoid excessive overpressure to the sensor! Externally mounted relief valves to provide overpressure protection are available from Mensor as optional devices, and are highly recommended for very low pressure sensors (less than 10 psi).

Portable Digital Pressure Gauge CPG2300 Series



Caution

CAUTION: It is recommended that a backup wrench be used when installing fittings or connections on the CPG2300.



Caution

CAUTION: Use of a power supply other than the one provided by Mensor will invalidate the warranty.



CAUTION: ESD PROTECTION REQUIRED.

The proper use of grounded work surfaces and personal wrist straps are required when coming into contact with exposed circuits (printed circuit boards) to prevent static discharge to sensitive electronic components.

Additional notices are found throughout this manual.

3. Product Description

3.1 General Description

The CPG2300 Digital Pressure Gauge is a portable battery powered instrument that provides very high accuracy pressure measurements. This instrument utilizes very high stability silicon sensors that are electronically compensated for pressure linearity over the entire operating temperature range. The CPG2300 also has a standard RS-232 serial port that can be used for remote communications.

Different models are available including the Model 2310 (single channel) and the Model 2320 (dual channel). These channels are referred to as Channel A and Channel B, and can operate independent of each other. Viewed from the front, Channel A is the sensor on the top left of the instrument and can be ordered with any available pressure range (see the Specifications section). Channel B is the sensor on the top right of the instrument and can be ordered with pressure ranges from 5 to 1000 psig (7.5 to 1000 psia).

Additionally, the CPG2300 can be equipped with optional current measurement from 4 to 20 mA and a 24V dc loop power. See the Options section for more information.

3.2 Display

Several different display screens are presented while operating the CPG2300. Each screen is arranged into blocks of information, generally organized into columns and rows. These screens are each described in further detail in the Local Operation and Remote Operation sections.

3.3 Power Supply

The power adapter is utilized to provide power to operate the CPG2300 and also to re-charge the internal batteries. It produces 12 Vdc @ 830 mA max.

3.4 Battery

The CPG2300 has an internal battery pack consisting of four 'AA' nickel-metal hydride batteries. The battery pack is replaceable and can be ordered from Mensor.

In pressure measurement mode the CPG2300 will operate approximately 20 hours on a fully charged new battery. There is a battery level indicator on the display that indicates the battery charge level. The battery level indicator will blink when there is approximately one hour of battery left. The unit will automatically shut off when the battery reaches a pre-determined level.

Portable Digital Pressure Gauge CPG2300 Series

Battery Charging: The CPG2300 has a built-in battery charger that will take approximately 8 hours with an input supply of 12 Vdc to fully recharge a battery. The built-in charger will switch from fast charge to maintenance mode automatically when a full charge is achieved. It is acceptable to leave the wall transformer connected to AC power indefinitely.

Charge Voltage vs. Temperature: The battery can be charged over an ambient temperature range of 0 to 40 degrees C with a supply voltage of 9 to 12 Vdc.

3.5 Serial In/Out Communications

The serial port is configured as RS-232, 9600 baud, 8 data bits, 1 stop bit and no parity. It is designed as a 9-pin DCE device, so that a straight pin to pin cable can be used to connect it to a standard PC serial port. The serial port can be used to configure and calibrate the CPG2300 or to read the output of its sensors.

Wiring requirements are provided in the Installation section and a list of valid commands and responses (Table 7.2.3) is provided in the Remote Operation section.

4. Specifications

Accuracy specifications presented herein are obtained by comparison with primary standards traceable to the National Institute of Standards and Technology (NIST). These specifications are obtained in accordance with the ISO Guide to the Expression of Uncertainty in Measurement (GUM). The calibration program at Mensor is accredited by the American Association of Laboratory Accreditation (A2LA) as complying with both the ISO/IEC 17025:2005 and the ANSI/NCSL Z540-1-1994 standards.

Mensor reserves the right to change specifications without notice.

Total Uncertainty	0.015% FS for ranges ≥ 1 psig (0.030% FS for ranges < 1 psig) over the compensated temperature range for 180 days.
Pressure Ranges	Channel A: 7.5 to 6015 psia 0.36 to 6000 psig Channel B: 7.5 to 1000 psia 5 to 1000 psig
Calibration Interval	180 days
Resolution	5 digits on display; 6 digits over serial port
Overpressure Limit	1.5 x span
Storage	-20 ... 70°C
Warmup	<1 minute
Reading Rate	~4.6 / second
Response Time	<252 mS
Orientation	Negligible >30 psi, zero offset resettable with zero calibration or null function.
Communications	RS-232, 9600 baud,N,8,1
Case size	T-shaped, 8.6 inches H x 4.3 inches W x 1.6 inches D
Weight	1.5 lbs.
Media Compatibility	Pressure port: Clean, dry, non-corrosive, non-combustible, non-oxidizing gases for all ranges. Ranges ≥ 5 psi: Media compatible with aluminum, 316 SS, Buna N, Viton, silicone grease and RTV. Not designed for oxygen service. Reference port: Clean, dry, non-corrosive gases.
Battery Life	20 hours

Portable Digital Pressure Gauge CPG2300 Series

Recharge Time	8 hours max.
Power Requirements	+9 to +14.5 Vdc, 830mA max for battery recharge.
Fittings	1/4 inch FNPT pressure ports, nom. 1/16 inch hose barb for ref ports.
Warranty	One year
Options	Carrying pouch - attaches to belt Hand pump Relief valves (mounted externally)
Current Input Option	Battery life: ~4 hours with loop power @ 20mA, and 10 hours with loop power @ 4mA. Current measurement: 4 to 20 mA (calibrated). Loop power voltage: 24V unregulated. Current uncertainty: if span < 5psig, 0.03% R. If span ≥ 5 psig, 0.015% R.
Units	psi, inHg @0C and 60F, inH2O @4C, 20C, bar, mbar, mmHg @ 0C, cmHg @0C, hPa, kPa, Pa, MPa, kg/sq cm, cmH2O @4C, cmH2O @20C, mSW @0C.
Display	Monochrome 128 x64 LCD, with white LED back light.

5. Installation

5.1 Unpacking the Instrument

In addition to functional testing, each unit is inspected for appearance prior to leaving the factory. Upon receipt, please examine the transducer for shipping damage. Report any apparent damage to the carrier immediately.

In addition to this manual you should have:

- CPG2300 Digital Pressure Gauge;
- Power adapter (charger)
- Any accessories ordered;
- An envelope containing the Calibration Certificate.

Portable Digital Pressure Gauge CPG2300 Series

5.2 Dimensions



Figure 5.2 - Case Outline/Dimensions

5.3 Pressure Connections

The left 1/4 inch FNPT threaded port is used to measure the pressure on Channel A of the CPG2300. If the sensor range is less than 20 psi and is a gauge or bi-directional sensor, there will also be a 1/16 inch hose barb fitting beside the pressure port. The barb fitting provides access to the reference port of the sensor.

If the CPG2300 has a second pressure sensor installed, it will have a second 1/4 inch FNPT threaded port on the right to measure the pressure on Channel B. If its range is less than 20 psi and it is a gauge sensor, a barb fitting provides access to the reference port of the sensor.



Caution

CAUTION: Avoid excessive overpressure to the sensor! Externally mounted relief valves to provide overpressure protection are available from Mensor as optional devices, and are highly recommended for very low pressure sensors (less than 10 psi).



Caution

CAUTION: It is recommended that a backup wrench be used when installing fittings or connections on the CPG2300.

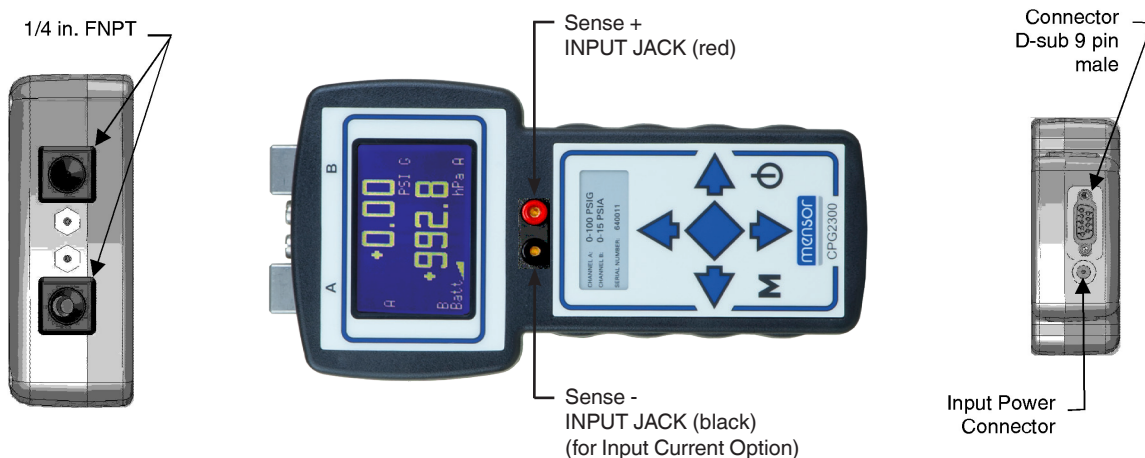

Figure 5.3 - Pressure and Electrical Connections

Portable Digital Pressure Gauge CPG2300 Series

5.4 Electrical Connections

For RS-232 serial port operation, connect the CPG2300 to the host computer per Figure 5.4a. Notice that the host TRANSMIT line is connected to the CPG2300 RECEIVE line (TX to RX), and vice versa.

The power connector is a 2.1 mm standard power jack. The center pin is +12 Vdc and the outside is ground (see Figure 5.4b).



Figure 5.4a - RS-232 Hookup



Figure 5.4b - DC Input

5.5 Power On

After the pressure connections are secure, press the power switch (). The CPG2300 will run through a brief initialization sequence and then will display the sensor channel(s) that was active when turned off last.

6. Local Operation

6.1 Keypad

A brief description of the keypad features and the display is provided below in Figure 6.1, “Keypad and Display Features”.



Figure 6.1 - Keypad and Display Features

Portable Digital Pressure Gauge CPG2300 Series

6.2 Standard Display

When the CPG2300 is powered on, the sensor channel(s) that was active when the CPG2300 was turned off previously will be displayed after the initialization screen. The standard display screen is shown below.

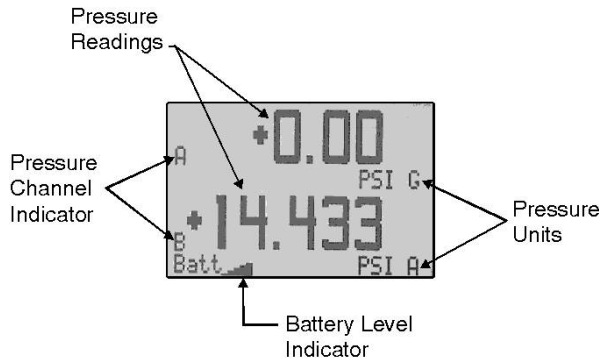

Figure 6.2 - Standard Display Screen

6.3 Menu Screens

All the menu screens can be navigated by use of the arrow keys. To select a menu item, highlight the item and press the \leftarrow (enter) key.

6.3.1 Main Menu Screen

If the **M** (menu) key is pressed at any time, the main menu is displayed on the screen. If one sensor is installed in the CPG2300, the Sensor A setup screen is displayed. If two sensors are installed in the CPG2300, the following will be displayed:

Main Menu	
Sensor A	A Setup
Sensor B	B Setup
Sensor A&B	

The items in this menu perform the following functions when selected:

Sensor A: Displays only the A Sensor.

Sensor B: Displays only the B Sensor.

Sensor A&B: Displays both the A and the B Sensor.

Sensor A setup: Displays the Sensor A setup screen.

Sensor B setup: Displays the Sensor B setup screen.

6.3.2 Sensor Setup Menu

Both the Sensor A and Sensor B setup menu screens are identical. These menus allow setup of various functions for the selected sensor.

A Setup	
Peak Off	Peak Rst
Null Off	Cal
Units	

B Setup	
Peak Off	Peak Rst
Null Off	Cal
Units	

The items in this menu perform the following functions when selected:

Peak Off (On): Toggles the peak indicator for the active sensor.

A Setup	
Peak On	Peak Rst
Null Off	Cal
Units	

The current condition of the peak indicator is displayed. If the menu item displays “Peak Off”, the peak indicator is disabled for the active sensor. If “Peak Off” is selected, it will enable peak capture for the active sensor. If the Sensor Setup menu is re-entered, the menu item will display “Peak On” to indicate that the peak capture function is enabled.



Notice

Peak readings are displayed only when a single channel is selected.

Peak Reset: Resets the peak values to the active measured pressure.

A Setup	
Peak Off	Peak Rst
Null Off	Cal
Units	

Portable Digital Pressure Gauge

CPG2300 Series

Null Off (On): Toggles the null function for the active sensor.

A Setup	
Peak Off	Peak Rst
Null On	Cal
Units	

The current state of the null function is displayed. If the menu item displays “Null Off”, the null function is disabled for the active sensor. If “Null Off” is selected, the CPG2300 will subtract the current measured pressure from any subsequent pressure readings. Unlike the Peak function, the Null function can be displayed on the main operation screen with both sensors pressures displayed. A capital “N” appears just above the “A” or “B” on the main operation screen to indicate that the sensor channel is currently using a null offset.

Single button null: The null feature can also be accessed by pressing the ◀ (enter) key while at the standard Display. When both channels are displayed, pressing the null button once will null channel A. Pressing the null button a second time will null channel B. Pressing the null button a third time will un-null channel A and a fourth press will un-null channel B. When a single channel is displayed the null button will toggle nulling on or off. The instrument will revert to the un-nulled state if power is cycled.



Notice

1. Peak and Null functions can be used simultaneously.
2. Pressure units must not be changed when using the null feature.

Cal: Displays the calibration password entry screen.

A Setup	
Peak Off	Peak Rst
Null Off	Cal
Units	



Units: Displays the first of the three units screens.

PSI	InHg 0c
InHg 60f	InH2O 4c
InH2O 20c	mBAR
BAR	more

6.3.3 Password Entry Screen

If the calibration function is selected from the sensor setup screen, the password entry screen will be displayed:



The four digit password can be entered by moving the cursor with the left and right arrow keys under the digit to be changed and then pressing the up or down arrow keys to scroll through the numbers 0 to 9. When the password is entered, press the ◀ (enter) key. The active channel's calibration screen will be displayed.

6.3.4 Sensor Calibration Screen

The sensor calibration screen allows the zero and span of the active sensor to be adjusted, the calibration to be reset to the factory defaults, and the calibration password to be changed.

A Calibration	
Cal Zero	Cal Span
Change PW	Reset Cal

The items in the calibration menu perform the following functions when selected:

Cal Zero: Displays the measured pressure for the active sensor.

MA Calibration	
Cal Zero	Cal Span
Change PW	Reset Cal

Adjust the digits to the true pressure applied to the active sensor and press the ◀ (enter) key to store the value. For more details, see the Calibration section.

Cal Span: Displays the measured pressure for the active sensor.

MA Calibration	
Cal Zero	Cal Span
Change PW	Reset Cal

Adjust the digits to the true pressure applied to the active sensor and press the ◀ (enter) key to store the value. For more details, see the Calibration section.

Portable Digital Pressure Gauge CPG2300 Series

Change Password:

A Calibration	
Cal Zero	Cal Span
Change PW	Reset Cal

Sensor A Calibration Password Entry 0000 Enter to Continue
--

Move the cursor with the left and right arrow keys under the digit to be changed. Increment the digit with the up and down arrow keys. When the password has been changed, press the **↵** (enter) key to store it. The main menu is then displayed.



Caution

The password is set to “0000” at the factory. When making a change write it down and save the number. If the password is lost contact Mensor.

Reset Cal: Displays a confirmation screen.

A Calibration	
Cal Zero	Cal Span
Change PW	Reset Cal

Reset Calibration Sensor B Are you Sure? Enter to Reset Other Keys to Quit
--

If the **↵** (enter) key is pressed, the calibration is reset to the factory defaults and the main operation screen is displayed. If any other key is pressed, the main menu screen is displayed.

6.3.5 Units Screens



Notice

Pressure units must not be changed when using the null feature.

There are three units screens that allow selection of the most common pressure units:

PSI	InHg 0c
InHg 60f	InH2O 4c
InH2O 20c	mBAR
BAR	more

mmHg 0c	cmHg 0c
Pa	hPa
kPa	mPa
ks/cm ²	more

cmH2O 4c	cmH2O 20c
MSW	User
Set User	more

The pressure unit of the active sensor is selected by highlighting the desired unit and pressing the **↵** (enter) key. To advance to the next units screen, select “more”. The last units screen allows selection and entry of a special “User” unit. The User unit has a configurable conversion factor that converts from PSI to the desired value. To enter the conversion factor, select “Set User” on the last units screen to display:

Set User Units A
+1.00000e+1
Enter to Continue

Use the left and right arrow keys to move the cursor under the digit to change and the up and down arrow keys to increment the digit. The conversion factor can be set from -1.00000e+6 to -1.00000e-6 and +1.00000e-6 to +1.00000e+6. Press the **↵** (enter) key to store the conversion factor. To apply the “user” conversion factor, the units “User” must be selected for the active sensor.



Notice

For the remote programmable pressure units list and information, see “User Programmable Pressure Units List” in the Remote Operation section of this manual.

Portable Digital Pressure Gauge CPG2300 Series

6.4 Menu Tree

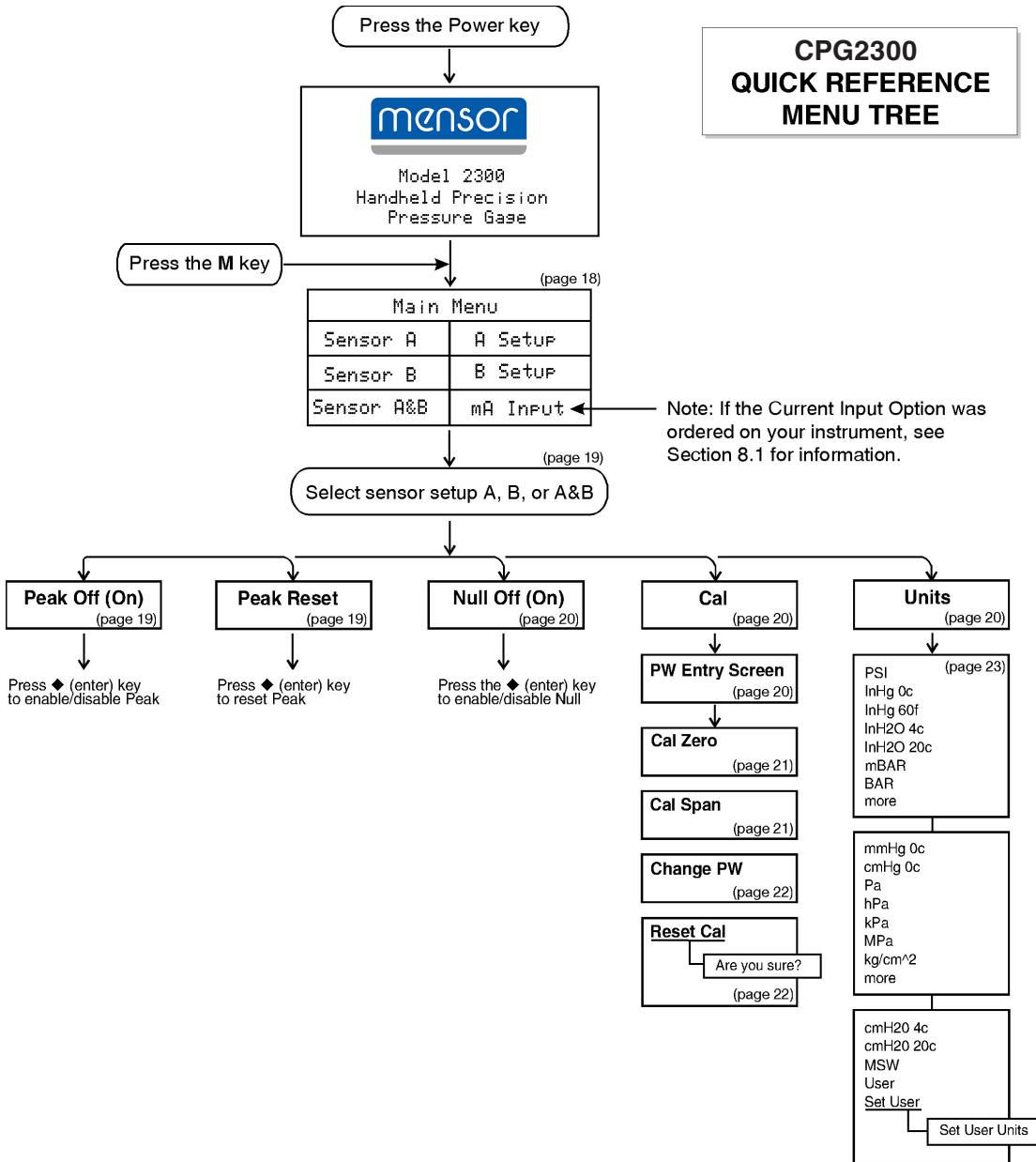

Figure 6.4 - CPG2300 Menu Tree

7. Remote Operation

7.1 General

The CPG2300 can be operated from a remote computer which communicates over a standard RS-232 serial port. The serial port can be used to configure and calibrate the CPG2300, or to read the output of its sensors. This section of the manual provides information on the serial port configuration, explains the command conventions used in this manual, and lists the common commands and queries which are recognized by the CPG2300.

7.2 Communication Syntax and Command Conventions

All commands and responses are in ASCII characters. The lower and upper case are interpreted the same. Every command or query begins with the pound symbol (#). The question mark (?) character is significant to the CPG2300. All other punctuation characters are ignored. Some commands require a password string. A carriage return (<cr>) and/or linefeed (<lf>) must terminate each command or query. The global address character is an asterisk (*). It can be sent in place of the actual CPG2300 address.

All of the commands are channel dependent. If sensor A is selected by sending #XCH A, all subsequent queries and commands work on channel A until #XCH B is sent. The active channel should always be checked before sending commands, as the channel status can be controlled by keypad also. Upon power-on the active channel is dependent on pressure display. Channel B is active when sensor B only is displayed. For all other pressure displays (A or A&B) the Channel A is active. In the case of a single channel unit, Channel A is always active.

It is good practice to query for the active channel before sending commands that change a sensors operating parameters. See Table 7.2.3 for commands and queries.

Portable Digital Pressure Gauge CPG2300 Series

7.2.1 Password Protection

Certain commands require a password to be sent before a setting is changed. The password is only effective for the next command, so the password must be sent immediately before any password protected command string. The password string is the password set in the CPG2300. The password is set at the factory to “0000”. However, for calibration protection, the actual password has been replaced with PW in the command string example.

7.2.2 Response String Format

All strings sent by the CPG2300 are terminated by a carriage return <cr> and linefeed <lf>. The CPG2300 will return an “R” character (ASCII 82) to indicate that it has received a valid command or password rather than a query. If an invalid command or password is sent, the “R” character will not be returned. When communicating with the CPG2300, the “R” character must be received before sending additional commands or queries. In the event that an invalid command could be sent, a time-out period of approximately one second should be used before sending the next command or query.

The full command word is shown in Table 7.2.3 in all capital letters. Other conventions used to describe commands are shown in Table 7.2.2.

Table 7.2.2 - Command Conventions

Convention	Description
X	Address (single character 0 through 9 or A through Z; case insensitive)
*	Global address character
?	Query operator
<sp>	Space ()
PW	Password (insert password in place of PW; case insensitive)
N	One character place holder for digit or decimal point
n...n	Variable length field
R	Ready response

7.2.3 Commands and Queries



Notice

Each command that changes a parameter is volatile until the SAVE command is issued.

Table 7.2.3 - Command Set

Pass- word Protect	Command / Query	Command String	Return String	Description
No	?	#X?<cr><lf>	The return string from a pressure reading query"?" can have different formats dependent upon how the unit is set up. If the LCD display is displaying sensors A & B and the "DSP?" query returns 3, the return string will return two values. The first is sensor A and the second is sensor B. Example format: 0 -0.001, +14.4561<cr><lf> If the LCD display is displaying either sensor A or B only and the "DSP?" query returns 1 or 2, the return string will return a single value from the selected sensor. Example format: 1 +14.4711<cr><lf> If the peak function is enabled the return string will contain three values. The first value is the maximum pressure, the second is the present pressure and the third is the minimum pressure. This return string is representative of the active channel. Note that when both channels are selected ("DSP?" = 3) the A & B readings are returned. Example of the peak return string format: 1 +14.7011, +14.4561, +14.3001<cr><lf>.	
No	A	#XA<sp>n<cr><lf>	R	Sets address of CPG2300 to 0-9 or A-Z.
No	CH?	#XCH?<cr><lf>	X<sp>n<cr><lf>	Returns active channel "A" or "B".
No	CH	#XCH<sp>n<cr><lf>	R	Sets active sensor channel where n is A or B.
No	CPW	#XCPW<sp>nn nn<cr><lf>	R	Enter customer password.

Portable Digital Pressure Gauge CPG2300 Series

No	CSC?	#XCSC?<cr><lf>	X<sp>n.nnn<cr><lf>	Available only with the Current Input option. Returns span correction multiplier for current measurement.
Yes	CSC	#XCSC<sp>n.nnn<cr><lf>	R	Available only with the Current Input option. Sets span correction multiplier for current measurement. Ranges from .95 to 1.05.
No	CZC?	#XCZC?<cr><lf>	X<sp>n.nnn<cr><lf>	Available only with the Current Input Option. Returns the zero offset for the current measurement.
Yes	CZC	#XCZC<sp>n.nnn<cr><lf>	R	Available only with the Current Input Option. Sets the zero offset for current measurement. Ranges from +/- .8 mA.
No	DC?	#XDC?<cr><lf>	X<sp>DC<sp>nnnnn<cr><lf>	Returns the date of calibration where nnnnnn is mmddy.
Yes	DC	#XDC<sp>nnnnnn<cr><lf>	R	Loads the date of calibration where nnnnnn is mmddy.
No	DSP?	#XDSP?<cr><lf>	X<sp>DSP<sp>N<cr><lf>	Returns display mode where 1 = Sensor A, 2 = Sensor B, 3 = Sensors A&B
No	DSP	#XDSP<sp>n<cr><lf>	R	Loads display mode where 1 = Sensor A, 2 = Sensor B, 3 = Sensors A&B
No	FL?	#XFL?<cr><lf>	X<sp>FL<sp>nn<cr><lf>	Returns the filter percentage.
No	FL	#XFL<sp>nn<cr><lf>	R	Sets the filter percentage ranges from 0 to 99.
No	FS?	#XFS?<cr><lf>	X<sp>FS<sp>nnnnn<cr><lf>	Returns the CPG2300 accuracy.
No	I?	#XI?<cr><lf>	X<sp>nn.nnn<cr><lf>	Available only with the Current Measurement option; Returns current measurement in milliamps.
No	ID?	#XID?<cr><lf>	X<sp>ID<sp>nn MENSOR, <sp>nnnn 64nn,<sp>nnnnnnnn, <sp>Vn.nn<cr><lf>	Returns the CPG2300 ID string.
No	NOS?	#XNOS?<cr><lf>	X<sp>NOS<sp>n<cr><lf>	Returns number of sensors installed in the CPG2300.

Portable Digital Pressure Gauge CPG2300 Series

No	NULL?	#XNULL? <cr><lf>	X<sp>NULL<sp>n <cr><lf>	Returns mode status of active sensor for null where n = 0 = OFF, n = 1 = ON
No	NULL	#XNULL<sp>n<cr> <lf>	R	Sets null mode on or off for current channel where n = 0 = OFF, n = 1 = ON.
No	PEAK?	#XPEAK? <cr><lf>	X<sp>PEAK<sp>n <cr><lf>	Returns mode status of active sensor for peak capture where n = 0 = OFF, n = 1 = ON
No	PEAK	#XPEAK<sp>n <cr><lf>	R	Sets peak mode on or off for current channel where n = 0 = OFF, n = 1 = ON.
No	R-?	#XR-? <cr><lf>	X<sp>R-<sp>nnnn <cr><lf>	Returns minimum pressure range of active sensor in PSI.
No	R+?	#XR+? <cr><lf>	X<sp>R+<sp>nnnn <cr><lf>	Returns maximum pressure range of active sensor in PSI.
No	RST<sp>	#XRST<sp><cr> <lf>	R	Resets peak values for the active sensor. A space must be included after the RST command.
No	SAVE	#XSAVE<cr><lf>	R	Saves all data to memory.
No	SC?	#XSC? <cr><lf>	X<sp>SC<sp>nnn nnnn<cr><lf>	Returns the span correction multiplier for the active sensor.
Yes	SC	#XSC<sp>nnnnnn <cr><lf>	R	Sets the span correction multiplier for the active sensor.
Yes	SCPW	#XSCPW<sp>nnnn <cr><lf>	R	Sets the customer password.
No	T?	#XT? <cr><lf>	X<sp>T<sp>n<cr> <lf>	Returns the pressure type for the active sensor; A = Absolute, G = Gauge, B = Bi-directional.
No	U?	#XU? <cr><lf>	X<sp>U<sp>nn<cr> <lf>	Returns pressure unit code. For a complete list of pressure unit codes and conversions, see Table 7.2.5.
No	U	#XU<sp>nn<cr><lf>	R	Sets the units code for the active sensor.
No	USR?	#XUSR? <cr><lf>	X<sp>USR<sp>nn nnnnnnnnnn <cr><lf>	Returns the user unit multiplier for the active sensor.
No	USR	#XUSR<sp>n <cr><lf>	R	Sets user selected units for the active sensor. Ranges from -1.00000e+6 to -1.00000e-6 and from +1.00000e-6 to +1.00000e+6.

Portable Digital Pressure Gauge CPG2300 Series

No	UT?	#XUT? <cr><lf>	X<sp>UT<sp>N, <sp>N,<sp>N,... <cr><lf>	Returns the list of programmed pressure units.
No	UT	#XUT<sp>N<sp> N<cr><lf>	R	Loads the programmable units list. The first number is the sequential position in the list from 0 to 7 and the second number is the unit code as according to Table 7.2.5.
No	ZC?	#XZC? <cr><lf>	X<sp>ZC<sp>nn nnnn<cr><lf>	Returns the zero offset for the active sensor.
Yes	ZC	#XZC<sp>nnnnn <cr><lf>	R	Sets the zero offset for the active sensor.

7.2.4 User Programmable Pressure Units List

The remote command **UT** can be used to modify the default pressure units available on the units display screen. The user can select from one to eight units to be displayed by sending a sequence of “UT” commands. The syntax is as follows:

#*UT<sp>n<sp>n<cr><lf> where the first “n” is a value from 0 to 7 and represents the units sequential position in the displayed list. The second “n” represents the unit code from Table 7.2.5. If the first (0) unit in the sequence is assigned a value of “0” then the displayed units will default to all the available units from the factory. To display less than eight units, a “0” is assigned to the next unit in the sequence.

An example of the use of the “UT” command:

#*UT 0 1<cr><lf> - assigns the first unit displayed as PSI

#*UT 1 2<cr><lf> - the next unit displayed would be InHg 0C

#*UT 2 34<cr><lf> - the third unit displayed would be hPa

#*UT 3 0<cr><lf> - terminates the displayed units to this point

#*UT 0 0<cr><lf> - allows all factory units to be displayed and used



Notice

The “SAVE” command must be sent to make changes permanent.

7.2.5 Pressure Unit Codes and Conversions

Table 7.2.5 - Pressure Unit Codes and Conversions

Code	Pressure Unit	PSI Conversion Factor
0	Counts	N/A
1	psi	0
2	inHg 0C	2.036020
3	inHg 60F	2.041772
4	inH ₂ O 4C	27.680672
5	inH ₂ O 20C	27.729767
14	bar	0.06894757
15	mbar	68.94757
17	cmH ₂ O 4C	70.3089
19	mmHg 0C	51.71508
20	cmHg 0C	5.171508
22	kPa	6.894757
23	Pa	6894.757
26	kg/sq cm	0.07030697
27	mSW 0C (@3.5% salinity)	0.6838528
34	hPa	68.94757
36	MPa	0.006894757
38	cmH ₂ O 20C	70.4336
99	User	User settable

Portable Digital Pressure Gauge CPG2300 Series

Notes

8. Options

8.1 Current Input

The current input option is capable of measuring current from 3 to 24 milliamps (mA). The calibrated range is from 4 to 20 mA. The CPG2300 also provides a 24V dc loop power source which can be turned on or off and that will power most transmitters. The CPG2300 current measurement is protected from over-current or high voltage up to 50V. It also has circuitry to prevent damage if the loop power is enabled and the input terminals are shorted. To preserve battery life, the current measurement mode and loop power are turned off through a power cycle. The input section is protected from over-current or high voltage input by a comparator controlled mosfet that will limit the current to a nominal of 24.8 mA. When the resident loop power is enabled, the current limiter circuit will protect the instrument if the input terminals are shorted together.

8.1.1 Menu Screens

Main Menu: The current input is set up using the “mA Input” selection in the main menu. This menu item will not be displayed unless the current input option is installed. Select the setup screen by pressing the **↵** (enter) key.

Main Menu	
Sensor A	A Setup
Sensor B	B Setup
Sensor A&B	mA Input

mA Input Setup: The items in this menu perform the following functions when selected:

mA Input Setup
Display mA Off
Source V Off
Calibrate mA

Display mA Off (On): Enables/disables current measurement by toggling the enter key.

mA Input Setup
Display mA On
Source V Off
Calibrate mA

Portable Digital Pressure Gauge CPG2300 Series

Source V Off (On): Enables/disables 24V loop power source by toggling the enter key.

mA Input Setup
Display mA Off
Source V On
Calibrate mA

Calibrate mA: Displays the calibration password entry screen.

mA Input Setup
Display mA Off
Source V Off
Calibrate mA

Password Entry Screen: If the calibrate mA function is selected from the mA Input Setup screen, the password entry screen will be displayed:

<p>mA Calibration</p> <p>0000</p> <p>Enter to Continue</p>

mA Calibration Screen: The mA calibration screen allows zero and span to be adjusted, the calibration to be reset to the factory defaults or the calibration password to be changed.

MA Calibration	
Cal Zero	Cal Span
Change PW	Reset Cal

Cal Zero and Cal Span Screens: Digits are selected by using the right or left arrow keys. The selected digit has a cursor below it. Adjustments of the digit is by the up or down arrow keys. Current input zero and span adjustments are limited to 5% of the range (16 mA). This would be +/- 0.8 mA. Press enter key to store the change.

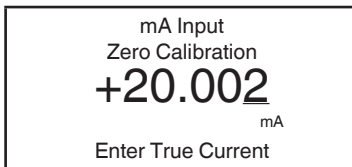
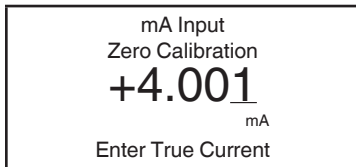

8.1.2 Operational Notes

When the current measurement option is enabled the value is displayed as the alternate channel to the pressure channel that is selected. This means when “Sensor A” is selected as the pressure measurement channel the pressure will be displayed as the top reading and the current measurement will be the bottom reading.



The display order is reversed when “Sensor B” is selected.



Both pressure channels can also be displayed while the current measurement channel is active by selecting “Sensor A&B”. The current measurement can then be acquired over the serial port. This is accomplished by issuing the “I?” command (see Remote Operation section).



Notice

The peak pressure indication function can not be enabled when the current input is enabled. The null feature will work when the current input is enabled.

Portable Digital Pressure Gauge CPG2300 Series

8.1.3 Connection Configurations

The diagrams shown are of typical current measurement connections. The insertion resistance is 100 ohms. The “Sense +” jack (red) is inserted on the high-side and the “Sense -” jack (black) is inserted on the low-side in the loop.



Notice

The pressure port fittings, and the d-sub shell of the RS-232 connector are electrically common to the “Sense -” connection each through 1 Meg ohm resistors. The RS-232 digital ground is connected directly to the “Sense -”. The connections should be isolated from the current loop connections.

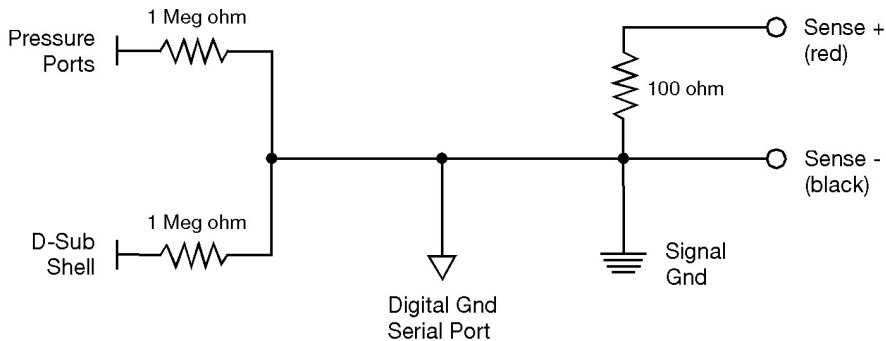

Figure 8.1.3 - Electrical Diagram (Current Input option)

8.1.4 Application Diagrams

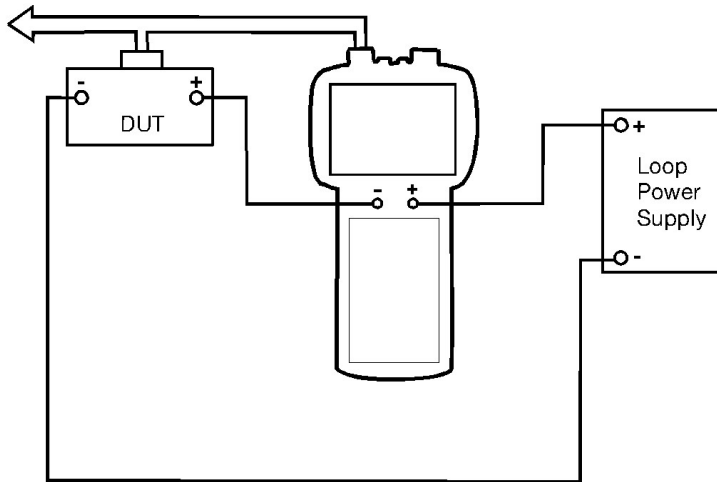

Figure 8.1.4a - Connections in a powered loop

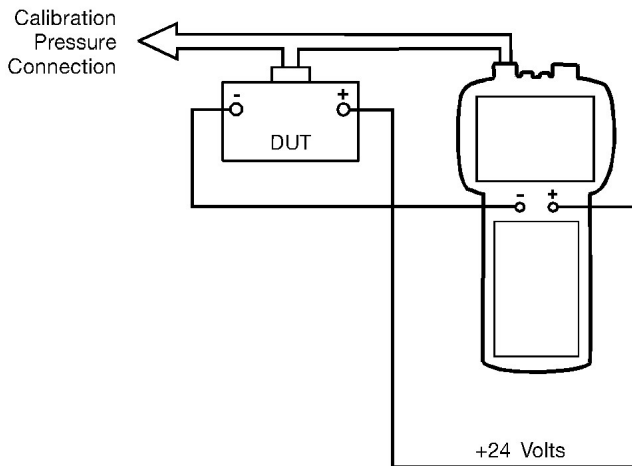

Figure 8.1.4b - Connections using CPG2300 loop power

Portable Digital Pressure Gauge CPG2300 Series

Notes

9. Calibration

The CPG2300 automatically adjusts the pressure readings for the effects of temperature and non-linearity within the calibrated temperature range of 0-50°C. Thus, a calibrated CPG2300 operated within its temperature band, and with proper zero and span settings, will provide accurate pressure measurements.

The sensor should have the span verified periodically to insure its stability. Initially, the recommended period between calibrations is 180 days. This period may be extended as confidence is gained in the span stability.

9.1 Environment

Whenever possible, calibrate the CPG2300 at the same ambient temperature as its normal operating environment. The temperature should be stable and within the specified calibration range. In addition, for maximum accuracy, see that the CPG2300 is at rest on a stable platform which is free of vibration and shock, and oriented similar to its operating attitude.

9.2 Equipment

Appropriate pressure and vacuum sources and calibration reference standards for the CPG2300's pressure range can be used. A vacuum pump capable of generating 600 mTorr absolute is recommended for calibrating zero-based absolute pressure transducers.

Refer to Figure 9.2 for an example of equipment setup.

Portable Digital Pressure Gauge CPG2300 Series

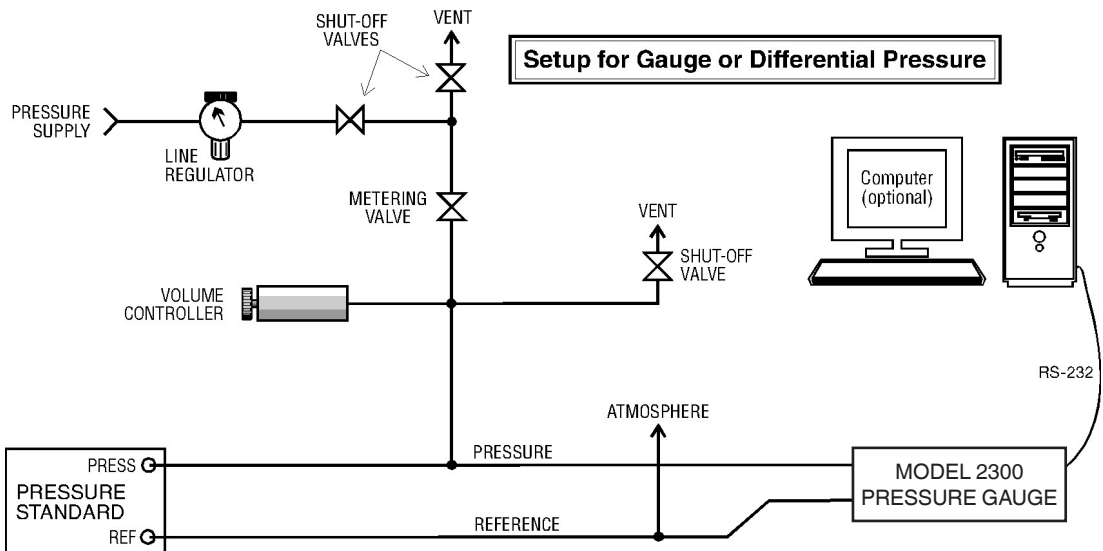
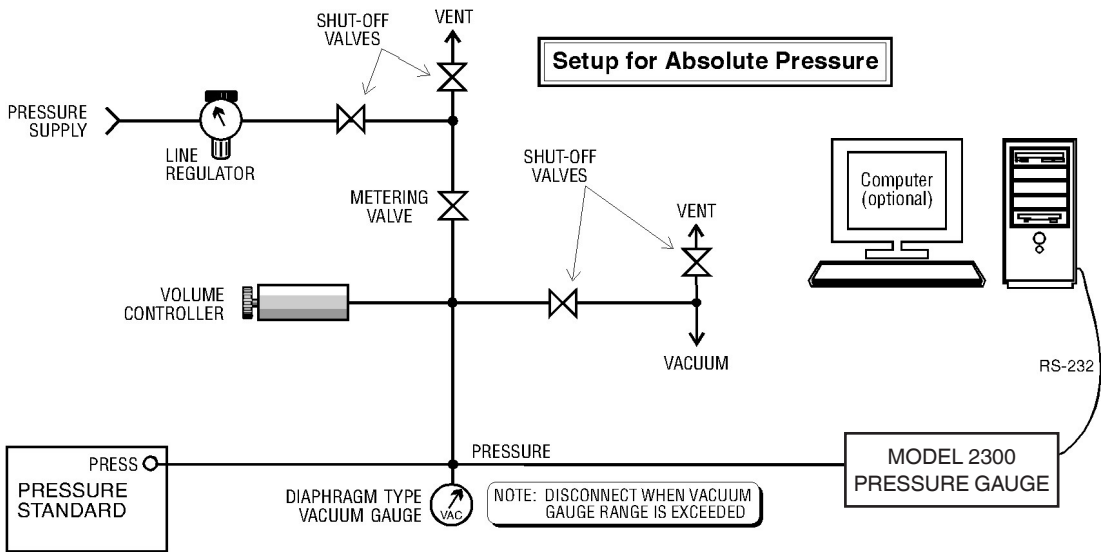

Figure 9.2 - Calibration Setup

9.3 Pressure Standard

Mensor recommends the use of appropriately accurate primary pressure standards when calibrating this instrument. Such standards should be sufficient so that when the techniques of the ISO Guide to the Expression of Uncertainty in Measurement (GUM) are applied, the instrument meets its accuracy statements as required by ISO 17025, or other applicable standards. The same requirement applies to the vacuum gauge used to set the zero offset on absolute calibrations. The recommended absolute pressure level for setting the zero offset is ≥ 300 millitorr.

9.4 Calibration Medium

The recommended calibration medium is dry nitrogen or clean, dry instrument air, however, special techniques must be used in filling the connection lines and transducer.

9.5 Calibration Process

The calibration process described below is for local operation via the instrument keypad. Connect the CPG2300 sensor to be calibrated as shown in Figure 9.2.

When the Calibration function is selected from the sensor setup screen, the password entry screen will be displayed. Enter the four-digit password and then press the \leftarrow (enter) key. For more information on entering or changing the password, see the Local Operation section.

9.5.1 Zero Adjustment

Access the zero calibration screen as described in the Local Operation section.

For gauge sensors: Vent the CPG2300 and adjust the display to show zero pressure by using the arrow keys on the front panel. When zero is shown, press the \leftarrow (enter) key.

For absolute sensors: Connect a vacuum source to the pressure port of the sensor to be calibrated. Evacuate the sensor to a low pressure between 600 mTorr absolute and 20% of the selected transducer's span. Allow sufficient time for the applied pressure to stabilize and adjust the measured pressure on the zero calibration screen to match the true applied pressure. Press \leftarrow (enter) key to store the zero offset.

9.5.2 Span Adjustment

Access the span calibration screen as described in the Local Operation section of this manual.

Set a known pressure to the pressure port of the sensor to be calibrated equal to, or near, the upper end of the range of the instrument. The applied pressure must be greater than 50% of the span or span adjustments will not be accepted. Adjust the measured pressure on the span calibration screen to match the true applied pressure. Press the \leftarrow (enter) key to store the span offset data.



Mensor Corporation

201 Barnes Drive
San Marcos, TX 78666 • USA
Tel. (+1) 512 3964200-15
Fax (+1) 512 3961820
E-Mail sales@mensor.com
www.mensor.com



**WIKAI Alexander Wiegand SE
& Co. KG**

Alexander-Wiegand-Straße 30
63911 Klingenberg • Germany
Tel. +49 9372 132-0
Fax +49 9372 132-406
info@wika.de

Imported to UK by:

WIKAI Instruments Ltd,
Unit 6 & 7 Goya Business Park,
The Moor Road, Sevenoaks
Kent, TN15 5GY