

Load pin

With thin-film technology up to 200 kN

Models F5301 standard, F53C1 with UL or F53C1 ATEX approvals

WIKA data sheet FO 51.18



For further approvals
see page 4

Applications

- Industrial weighing technology
- Crane systems and hoists
- Machine building and plant construction, manufacturing automation
- Chemical and petrochemical industries

Special features

- Measuring ranges 0 ... 5 kN to 0 ... 200 kN
[0 ... 1,124 lbf to 0... 44,962 lbf]
- Corrosion-resistant stainless steel version
- Integrated amplifier
- High long-term stability, high shock and vibration resistance
- Good reproducibility, easy installation

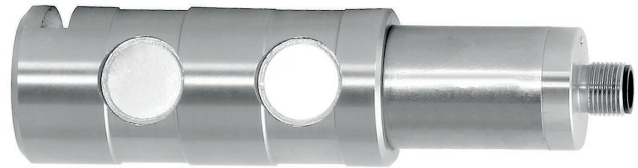

Load pin, model F5301

Description

Load pins are used for static and dynamic measuring tasks as replacements for non-measuring bolts. They are used to determine tension and/or compression forces.

Load pins of this model are mainly used in hoists and crane systems. They also serve as reliable sensors in industrial weighing technology and in the fields of production automation, machine-building and plant engineering, where they are used, in particular, in pulleys, cable winches, fork or roller bearings. The load pins have also proven themselves in the chemical and petrochemical industries.

The corresponding technical and regional approvals of these force transducers are, of course, available as options.

Model F5301 and F53C1 load pins are made of high-strength, corrosion-resistant 1.4542 stainless steel, the properties of which are particularly well-suited to the application areas of the load pins.

As output signals, the common active current and voltage outputs are available (4 ... 20 mA, 0 ... 10 V). Redundant output signals and CANopen® protocols are also possible.

Specifications per VDI/VDE/DKD 2638

Model	F5301 and F53C1 with UL approval						
Rated force F_{nom} kN	5	10	20	30	50	100	200
Rated force F_{nom} lbf	1,124	2,248	4,496	6,744	11,240	22,481	44,962
Relative linearity error $d_{lin}^{1)}$	$\pm 1 \% F_{nom}$						
Relative repeatability error in unchanged mounting position b_{rg}	$\pm 0.2 \% F_{nom}$						
Temperature effect on							
the characteristic value TK_c	0.2 % F_{nom} / 10 K						
the zero signal TK_0	0.2 % F_{nom} / 10 K						
Force limit F_L	150 % F_{nom}						
Breaking force F_B	300 % F_{nom}						
Transverse force effect d_Q (signal at 100 % F_{nom} under 90°)	$\pm 5 \% F_{nom}$						
Rated displacement (typical) s_{nom}	< 0.1 mm [< 0.004 in]						
Material of the measuring body	<ul style="list-style-type: none"> ■ Corrosion-resistant stainless steel, 1.4542, ultrasound-tested 3.1 material ■ With 3.2 material 						
Rated temperature $B_{T, nom}$	-20 ... +80 °C [-4 ... +176 °F]						
Service temperature $B_{T, G}$	-30 ... +80 °C [-22 ... +176 °F]						
Storage temperature $B_{T, S}$	-40 ... +85 °C [-40 ... +185 °F]						
Electrical connection	<ul style="list-style-type: none"> ■ Circular connector M12 x 1, 5-pin ■ CANopen® M12 x 1, 5-pin circular connector 						
Output signal (rated characteristic value) C_{nom}	<ul style="list-style-type: none"> ■ 4 ... 20 mA, 2-wire ■ 4 ... 20 mA, 3-wire ■ 2 x 4 ... 20 mA ■ DC 0 ... 10 V, 3-wire ■ 2 x DC 0 ... 10 V ■ CANopen® <p>Protocol in accordance with CiA® 301, device profile CiA® 404, communication services LSS (CiA® 305), configuration of the instrument address and baud rate Sync/Async, Node/Lifeguarding, heartbeat; zero and span $\pm 10 \%$ adjustable via entries in the object directory ²⁾</p>						
Current/power consumption	<ul style="list-style-type: none"> ■ Current output 4 ... 20 mA 2-wire: signal current ■ Current output 4 ... 20 mA 3-wire: < 8 mA ■ Voltage output: < 8 mA ■ CANopen®: <1 W 						
Supply voltage UB	<ul style="list-style-type: none"> ■ DC 9 ... 36 V for current output ■ DC 13 ... 36 V for voltage output ■ DC 9 ... 36 V for CANopen® 						
Load	<ul style="list-style-type: none"> ■ $\leq (UB - 10 V) / 0.024 A$ for current output ■ > 10 kΩ for voltage output 						
Reponse time	≤ 2 ms (within 10 ... 90 % F_{nom}) ³⁾						
Ingress protection (per IEC/EN 60529)							
Unplugged state	IP66, IP67						
Plugged-in state	IP68, IP69, IP69K						
Electrical protection	Reverse polarity protection, overvoltage and short-circuit resistance						
Vibration resistance	20g, 100 h, 50 ... 150 Hz (in accordance with DIN EN 60068-2-6)						
Shock resistance	In accordance with DIN EN 60068-2-27						
Immunity	In accordance with DIN EN 61326-1/DIN EN 61326-2-3 (optional EMC-strengthened versions)						
Intended use	Indoor and outdoor use, typically at altitudes of up to 2,500 m [8,202.5 ft] above sea level.						

1) Relative linearity error is specified in accordance with Directive VDI/VDE/DKD 2638 chapter 3.2.6.

2) Protocol in accordance with CiA® 301, device profile CiA® 404, communication service LSS (CiA® 305).

CANopen® and CiA® are registered community trademarks of CAN® in Automation e. V.

3) Further response times possible on request.

Specifications per VDI/VDE/DKD 2638

Model	F53C1 for ATEX/IECEX EX ib ¹⁾				F5301 for signal jump		
Rated force F_{nom} kN	5	10	20	30	50	100	200
Rated force F_{nom} lbf	1.124	2.248	4.496	6.744	11.240	22.481	44.962
Relative linearity error d_{lin} ²⁾	$\pm 1 \% F_{nom}$						
Relative repeatability error in unchanged mounting position b_{rg}	$\pm 0.2 \% F_{nom}$						
Temperature effect on							
the characteristic value TK_c	0.2 % F_{nom} / 10 K						
the zero signal TK_0	0.2 % F_{nom} / 10 K						
Force limit F_L	150 % F_{nom}						
Breaking force F_B	300 % F_{nom}						
Transverse force effect d_Q (signal at 100 % F_{nom} under 90°)	$\pm 5 \% F_{nom}$						
Rated displacement (typical) s_{nom}	< 0.1 mm [< 0.004 in]						
Material of the measuring body	<ul style="list-style-type: none"> ■ Corrosion-resistant stainless steel, 1.4542, ultrasound-tested 3.1 material ■ With 3.2 material 						
Rated temperature $B_{T, nom}$	-20 ... +80 °C [-4 ... +176 °F]						
Service temperature $B_{T, G}$	Ex II 2G Ex ib IIC T4 Gb -25 °C < Tamb < +85 °C Ex II 2G Ex ib IIC T3 Gb -25 °C < Tamb < +100 °C Ex I M2 Ex ib I Mb -25 °C < Tamb < +85 °C Ex II 2G Ex ib IIC T4 Gb -40 °C < Tamb < +85 °C Ex I M2 Ex ib I Mb				-30 ... +80 °C [-22 ... +176 °F]		
Storage temperature $B_{T, S}$	-40 ... +85 °C [-40 ... +185 °F]						
Electrical connection	<ul style="list-style-type: none"> ■ M12 x 1 circular connector, 4-pin ■ Cable gland 						
Output signal (rated characteristic value) C_{nom}	<ul style="list-style-type: none"> ■ 4 ... 20 mA, 2-wire 				<ul style="list-style-type: none"> ■ 4 ... 16 mA, 2-wire ³⁾ ■ DC 2 ... 8 V, 3-wire ³⁾ 		
Current/power consumption	<ul style="list-style-type: none"> ■ Current output 4 ... 20 mA 2-wire: signal current 				<ul style="list-style-type: none"> ■ Current output 4 ... 20 mA 2-wire: signal current ■ Current output 4 ... 20 mA 3-wire: < 8 mA ■ Voltage output: < 8 mA 		
Supply voltage UB	DC 10 ... 30 V for current output				<ul style="list-style-type: none"> ■ DC 9 ... 36 V for current output ■ DC 13 ... 36 V for voltage output 		
Load	<ul style="list-style-type: none"> ■ $\leq (UB - 10 V) / 0.024 A$ for current output ■ > 10 kΩ for voltage output 						
Reponse time	≤ 2 ms (within 10 ... 90 % F_{nom}) ⁴⁾						
Ingress protection (per IEC/EN 60529)							
Unplugged state	IP67				IP66, IP67		
Plugged-in state					IP68, IP69, IP69K		
Electrical protection	Reverse polarity protection, overvoltage and short-circuit resistance						
Vibration resistance	20g, 100 h, 50 ... 150 Hz (in accordance with DIN EN 60068-2-6)						
Shock resistance	In accordance with DIN EN 60068-2-27						
Immunity	In accordance with DIN EN 61326-1/DIN EN 61326-2-3 (optional EMC-strengthened versions)						

1) The load pin with ignition protection type "ib" should only be powered using galvanically isolated repeater power supplies. Suitable repeater power supplies can be offered as an option, e.g. order no.: 14255084.

2) Relative linearity error is specified in accordance with Directive VDI/VDE/DKD 2638 chapter 3.2.6.







3) Further signal jumps are realisable on request.

4) Further reponse times possible on request.

Approvals

Logo	Description	Region
	EU declaration of conformity	European Union
	EMC directive	

Optional approvals

Logo	Description	Region
	ATEX directive ¹⁾ per EN 60079-0:2012 and EN 60079-11:2012 (Ex ib) Hazardous areas Ex ib Ex II 2G Ex ib IIC T4 Gb $-25\text{ °C} < T_{amb} < +85\text{ °C}$ Ex II 2G Ex ib IIC T3 Gb $-25\text{ °C} < T_{amb} < +100\text{ °C}$ Ex I M2 Ex ib I Mb ²⁾ $-25\text{ °C} < T_{amb} < +85\text{ °C}$ Ex II 2G Ex ib IIC T4 Gb $-40\text{ °C} < T_{amb} < +85\text{ °C}$	European Union
	IECEX ¹⁾ per IEC 60079-0:2011 (Ed. 6) and IEC 60079-11:2011 (Ed. 6) (Ex ib) Hazardous areas Ex ib Ex ib IIC T4/T3 Gb $-25\text{ °C} < T_{amb} < +85\text{ °C}$ Ex ib IIC T4 Gb $-25\text{ °C} < T_{amb} < +100\text{ °C}$ Ex ib I Mb ²⁾ $-25\text{ °C} < T_{amb} < +85\text{ °C}$ Ex ib IIC T4 Gb $-40\text{ °C} < T_{amb} < +85\text{ °C}$	International
	UL ¹⁾ per UL 61010-1 and CSA C22.2 NO. 61010-1 Component approval	USA and Canada
	EAC EMC directive	Eurasian Economic Community
	EAC Ex ¹⁾ Hazardous areas Ex ib Ex ib IIC T3 Gb $-40\text{ °C} < T_{amb} < +100\text{ °C}$ Ex ib IIC T3 Gb $-45\text{ °C} < T_{amb} < +100\text{ °C}$ Ex ib IIC T4 Gb $-40\text{ °C} < T_{amb} < +85\text{ °C}$ Ex ib IIC T4 Gb $-45\text{ °C} < T_{amb} < +100\text{ °C}$	Eurasian Economic Community
	DNV (option) Ships, shipbuilding (e.g. offshore) ■ DNV standard: DNV-ST-0377 ■ DNV standard: DNV-ST-0378	International

1) Only with model F53C1.

2) Only possible with cable gland.

→ For approvals and certificates, see website.

Dimensions in mm [in]

Version up to 10 kN [up to 2,248 lbf]

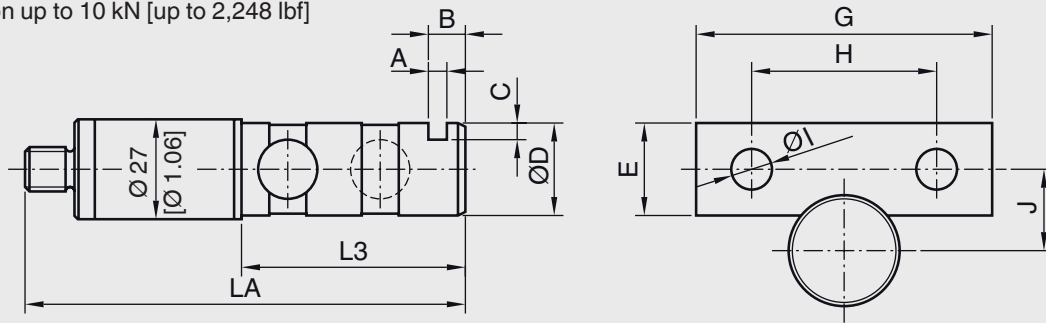

Version from 10 kN [from 2,248 lbf]

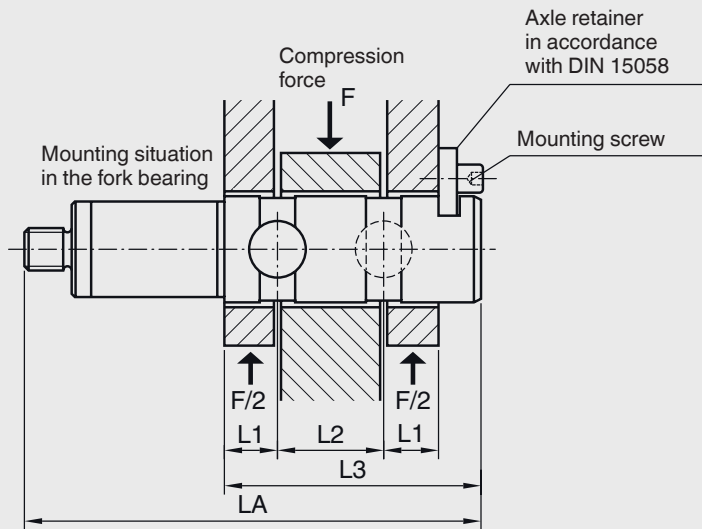
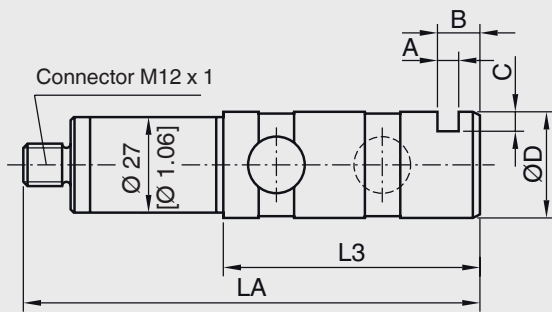

Other geometries on request

Rated force in kN	Dimensions in mm												
	LA	ØD ¹⁾	L1	L2	L3	A	B	C	E	G	H	ØI	J
5	115.5	20	10	20	50.5	5	10	4.0	20	60	36	9	16
10	125.5	25	12.5	25	60.5	5	10	4.5	20	60	36	9	18
20	135.5	30	15	30	72.5	6	12	5.5	25	80	50	11	22
30	145.5	35	17.5	35	82.5	6	12	6	25	80	50	11	24
50	160.5	40	22.5	40	97.5	6	12	6.5	25	80	50	11	26
100	175.5	50	23	50	112.5	8	16	7	30	100	70	13	33
200	223.5	70	35	70	160.5	10	20	10	40	140	100	17	45

Rated force in lbf	Dimensions in Inch												
	LA	ØD ¹⁾	L1	L2	L3	A	B	C	E	G	H	ØI	J
1,124	4.58	0.79	0.4	0.79	1.98	0.19	0.4	0.16	0.79	2.36	1.42	0.35	0.63
2,248	4.94	0.98	0.49	0.98	2.38	0.19	0.4	0.18	0.79	2.36	1.42	0.35	0.71
4,496	5.33	1.18	0.59	1.18	2.85	0.24	0.47	0.22	0.98	3.15	1.96	0.43	0.87
6,744	5.73	1.37	0.69	1.38	3.25	0.24	0.47	0.24	0.98	3.15	1.96	0.43	0.94
11,240	6.31	1.57	0.89	1.57	3.84	0.24	0.47	0.25	0.98	3.15	1.96	0.43	1.02
22,481	6.90	1.96	0.91	1.97	4.43	0.24	0.63	0.28	1.18	3.94	2.76	0.51	1.30
44,962	8.80	2.75	1.37	2.76	6.32	0.24	0.79	0.4	1.57	5.51	3.94	0.67	1.77

¹⁾ Bore/Bolt pairing: H9/f9

Mounting situation of the load pin

Pin retainer (in accordance with DIN 15058)

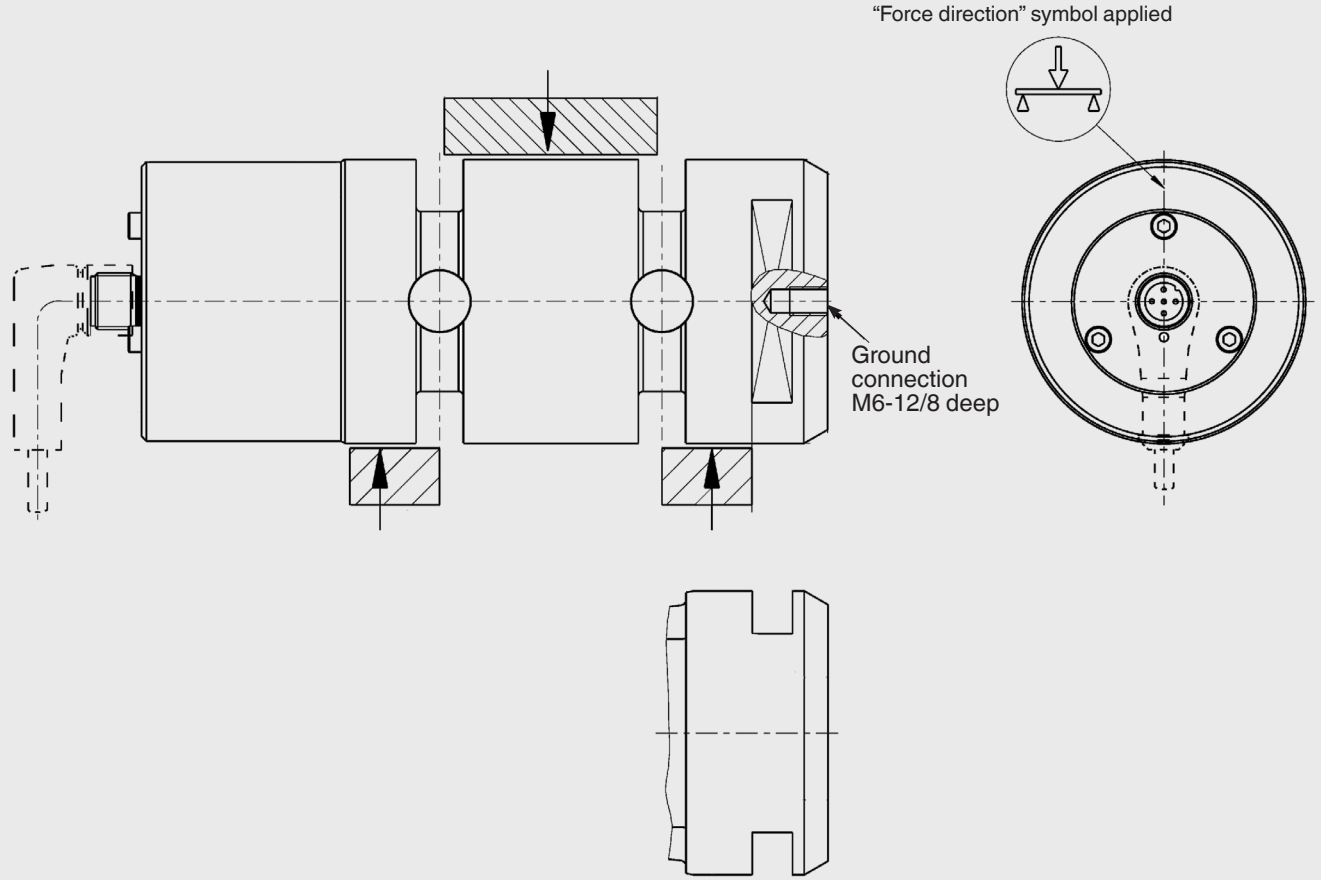

Dimensioning: The customer-specific load pin drawing of the respective order number has priority.

Pin assignment, analogue output

Abbreviations, definitions

Signal	Description
UB	Voltage source for the sensor
UB+	Sensor voltage supply (+)
UB-	Sensor voltage supply (-)
S+	Output signal (+)
S-	Output signal (-)
0 V	0 V potential

Signal	Description
(A)	Ammeter
(V)	Voltmeter
(+)	Voltage source
⌵	Switch
(⊕)	Shield (ground)

For models F5301 and F53C1 with UL approval

Output 4 ... 20 mA, 2-wire

Circular connector M12 x 1, 5-pin

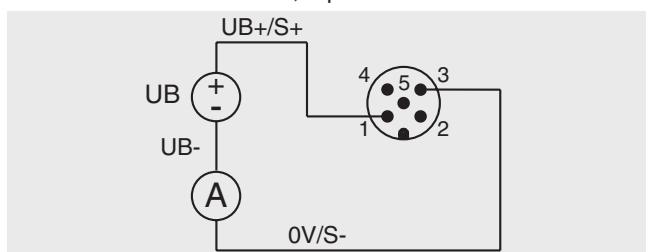

Signal	4 ... 20 mA, 2-wire	Cable colour
UB+/S+	1	Brown
0 V/S-	3	Black
Shield (⊕)	Case/Connector	-

Cable colours are only valid when using the standard WIKA cable, e.g. order number: 14259454

Output 4 ... 20 mA, 3-wire

Circular connector M12 x 1, 5-pin

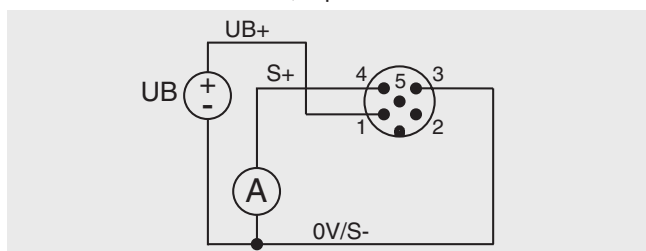

Signal	4 ... 20 mA, 3-wire	Cable colour
UB+	1	Brown
S+	4	Black
0 V/S-	3	Blue
Shield (⊕)	Case/Connector	-

Cable colours are only valid when using the standard WIKA cable, e.g. order number: 14259454

Output 0...10 V, 3-wire

Circular connector M12 x 1, 5-pin

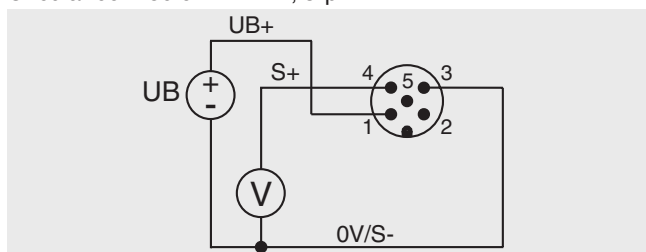

Signal	0 ... 10 V, 3-wire	Cable colour
UB+	1	Brown
S+	4	Black
0 V/S-	3	Blue
Shield (⊕)	Case/Connector	-

Cable colours are only valid when using the standard WIKA cable, e.g. order number: 14259454

For model F53C1

Output 4 ... 20 mA, 2-wire for ATEX Ex ib

Circular connector M12 x 1, 4-pin

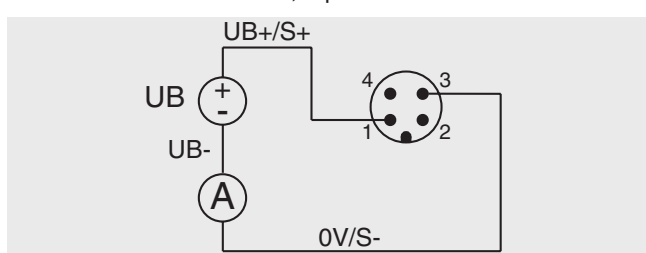





Signal	ATEX/IECEX Ex ib 4 ... 20 mA, 2-wire	Cable colour
UB+/S+	1	Brown
0 V/S-	3	Blue
Shield (⊕)	Case/Connector	-

Cable colours are only valid when using the standard WIKA cable, e.g. order number: 14259454

Pin assignment with signal jump

Abbreviations, definitions

Signal	Description
UB	Voltage source for the sensor
UB+	Sensor voltage supply (+)
UB-	Sensor voltage supply (-)
UR	Voltage source for the signal jump
UR+	Signal jump supply voltage (+)
UR-	Signal jump supply voltage (-)
S+	Output signal (+)
S-	Output signal (-)
0 V	0 V potential

Signal	Description
	Ammeter
	Voltmeter
	Voltage source
	Switch
	Shield (ground)

For model F5301 with signal jump

Output 4 ... 20 mA, 2-wire

Circular connector M12 x 1, 4-pin

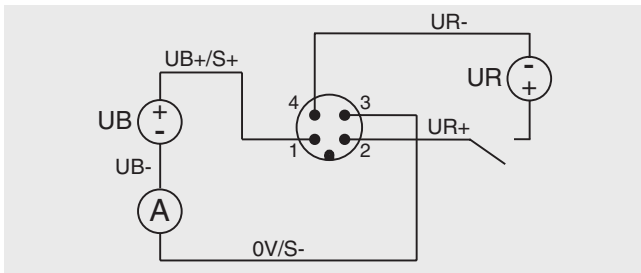



Signal	4 ... 20 mA, 2-wire	Cable colour
UB+/S+	1	Brown
0 V/S-	3	Blue
UR+	2	White
UR-	4	Black
Shield 	Case/Connector	-

Cable colours are only valid when using the standard WIKA cable, e.g. order number: 14259454

Output 4 ... 20 mA, 3-wire

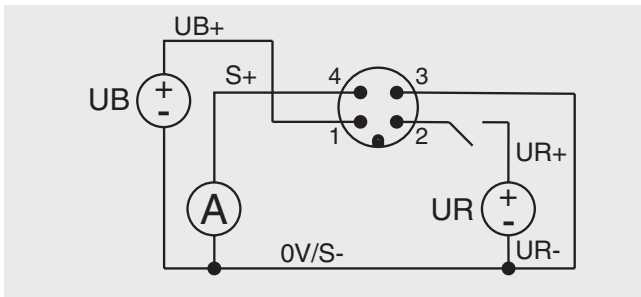
Circular connector M12 x 1, 4-pin





Signal	4 ... 20 mA, 3-wire	Cable colour
UB+	1	Brown
0 V/S-	3	Blue
UR+	2	White
UR-	3	Blue
S+	4	Black
Shield 	Case/Connector	-

Cable colours are only valid when using the standard WIKA cable, e.g. order number: 14259454

Output 0 ... 10 V, 3-wire

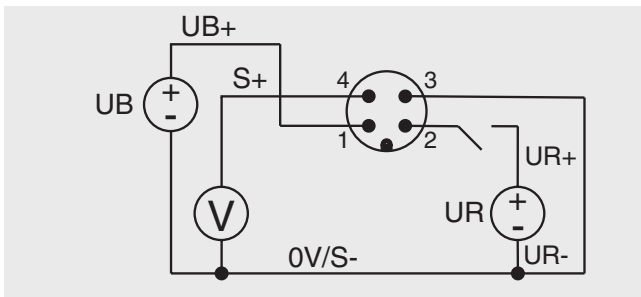
Circular connector M12 x 1, 4-pin



Signal	0 ... 10 V, 3-wire	Cable colour
UB+	1	Brown
0 V/S-	3	Blue
UR+	2	White
UR-	3	Blue
S+	4	Black
Shield 	Case/Connector	-

Cable colours are only valid when using the standard WIKA cable, e.g. order number: 14259454

Redundant pin assignment with 1 x connector

Abbreviations, definitions

Signal	Description
UB	Voltage source for the sensor
UB+	Sensor voltage supply (+)
UB-	Sensor voltage supply (-)
UR	Voltage source for the signal jump
S-	Output signal (-)
CH1	Channel 1
CH2	Channel 2
CH1+2	Channel 1 and channel 2
0 V	0 V potential

Signal	Description
	Ammeter
	Voltmeter
	Voltage source
	Switch
	Shield (ground)

For models F5301 and F53C1 with UL approval

Output 4 ... 20 mA, 2-wire

Circular connector M12 x 1, 5-pin

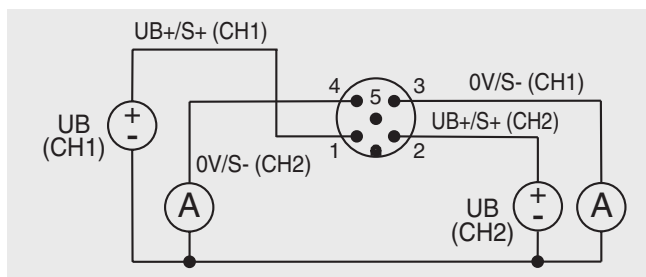

Signal	4 ... 20 mA, 2-wire	Cable colour
UB+/S+ (CH1)	1	Brown
UB+/S+ (CH2)	2	White
0 V/S- (CH1)	3	Blue
0 V/S- (CH2)	4	Black
Shield	Case/Connector	-

Cable colours are only valid when using the standard WIKA cable, e.g. order number: 14259454

Output 4 ... 20 mA, 3-wire

Circular connector M12 x 1, 5-pin

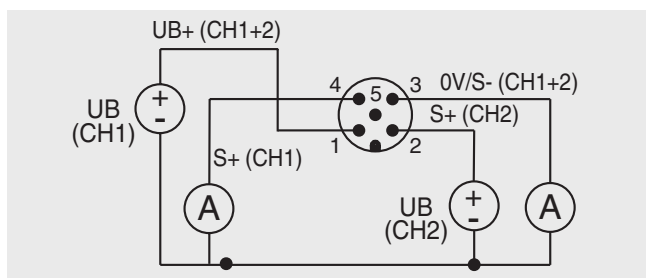

Signal	4 ... 20 mA, 3-wire	Cable colour
UB+ (CH1+2)	1	Brown
0 V/S- (CH1+2)	3	Blue
S+ (CH1)	4	Black
S+ (CH2)	2	White
Shield	Case/Connector	-

Cable colours are only valid when using the standard WIKA cable, e.g. order number: 14259454

Output 0 ... 10 V, 3-wire

Circular connector M12 x 1, 5-pin

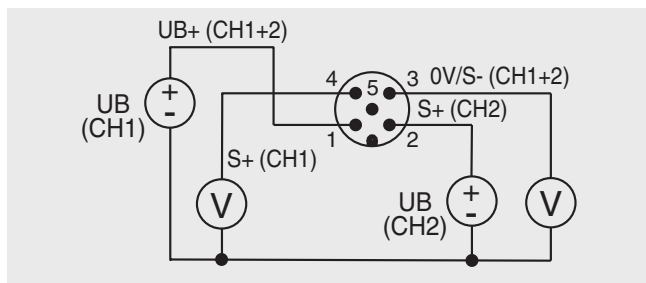

Signal	0 ... 10 V, 3-wire	Cable colour
UB+ (CH1+2)	1	Brown
0 V/S- (CH1+2)	3	Blue
S+ (CH1)	4	Black
S+ (CH2)	2	White
Shield	Case/Connector	-

Cable colours are only valid when using the standard WIKA cable, e.g. order number: 14259454

Pin assignment for CANopen® in accordance with CiA®303-1

Abbreviations, definitions

Signal	Description
CAN-SHLD, shield ⊕	Shield
CAN-V+	External positive voltage supply for the supply of the sensor
CAN-GND	External 0 V potential for the supply of the sensor
CAN-High	CAN_H bus line (dominant high)
CAN-Low	CAN_L bus line (dominant low)

For models F5301 and F53C1 with UL approval

CANopen®

Circular connector M12 x 1, 5-pin

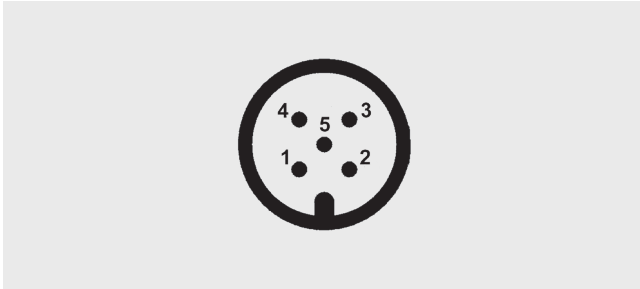

Signal	Pin	Cable colour
CAN-SHLD, shield ⊕	1/Case/Connector	Brown
CAN-V+	2	Blue
CAN-GND	3	White
CAN-High	4	Blue
CAN-Low	5	Black

Cable colours are only valid when using the standard WIKA cable, e.g. order number: 14259454

CANopen® with Y-connector

Socket M12 x 1, 5-pin / connector M12 x 1, 5-pin

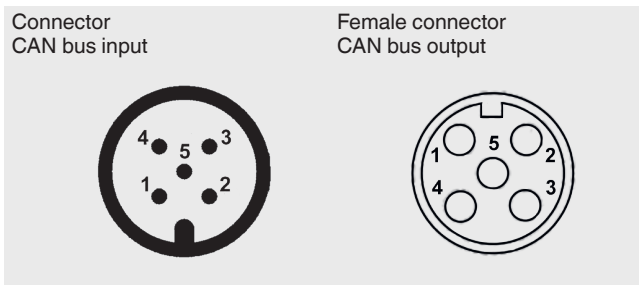

The socket and connector are connected internally.

Socket, M12 x 1, 5-pin / connector, M12 x 1, 5-pin		
Signal	Pin	Cable colour
CAN-SHLD, shield ⊕	1/Case/Connector	Brown
CAN-V+	2	Blue
CAN-GND	3	White
CAN-High	4	Blue
CAN-Low	5	Black

Cable colours are only valid when using the standard WIKA cable, e.g. order number: 14259454

Short description of signal jump electronics

Amplifier 4 ... 20 mA or 0 ... 10 V for signal jump applications with 2-channel computer control.

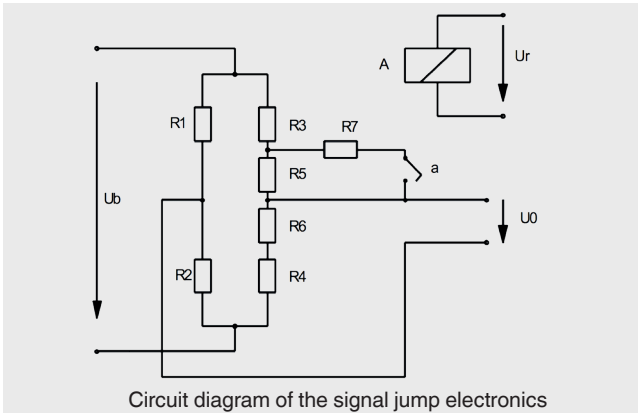

With these force transducers, four variable resistors (R1 ... R4) are connected together to form a Wheatstone bridge. When the measuring body deforms, the opposing resistors are stretched or compressed in the same way. This leads to a detuning of the bridge and a diagonal voltage U_0 .

The test resistor R7 is now important in connection with checking the subsequent amplifier circuit and the subsequent signal paths. This is switched parallel to the resistor R5 via the relay contact (a) as soon as the excitation voltage U_r of the relay A is present. The connection of the resistor R7 causes a defined, always constant, detuning of the zero point (diagonal voltage) of the Wheatstone bridge.

An external controller that is independent of the bending or shear beam must monitor the safe function of the bending or shear beam. The functional test with a signal jump of 4 mA / 2 V is executed at an interval of 24 hours. The controller activates the relay A, thus changing the output signal of the bending or shear beam in a defined manner.

If the expected signal change in the output signal occurs, it can be assumed that the entire signal path from the Wheatstone bridge per the amplifier through to the output is functioning correctly. If no signal change occurs, then it can be concluded that there is an error in the signal path.



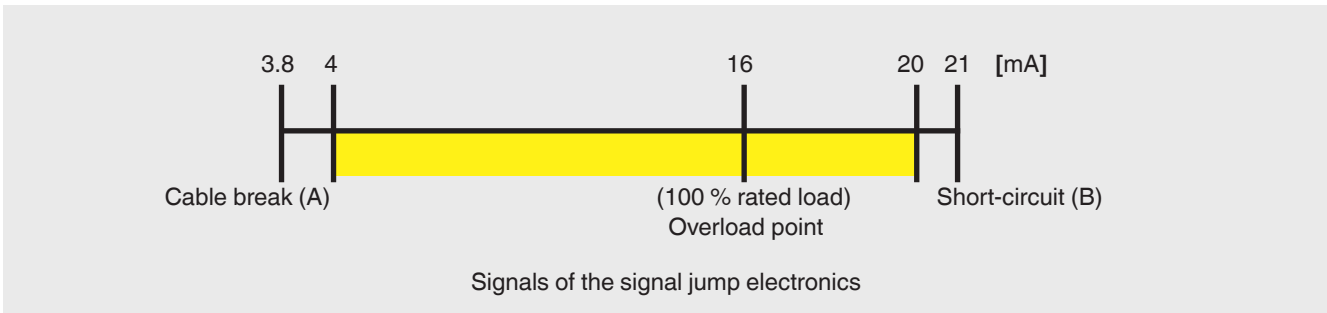

Furthermore, the measuring signal should be checked by the controller for min. (A) and max. (B) signal values in order to detect any cable breaks or short circuits that may occur.

The default setting of the bending or shear beam with a current output of 4 ... 20 mA for overload detection is, for example:



With a fixed signal jump of, for example, 4 mA, the test cycle can then be triggered, in any operating state, by activating the test relay. The upper measuring range limit of 20 mA will never be reached and thus the checking of the signal jump is enabled.

Accessories

Model EZE53 connector with moulded cable					
Model	Description	Temperature range	Cable diameter	Cable length	Order number
	Straight version, cut to length, 4-pin, PUR cable, UL listed, IP67	-20 ... +80 °C [-4 ... +176 °F]	4.75 mm - 5.7 mm [0.18 in - 0.22 in]	2 m [6.6 ft]	14259451
				5 m [16.4 ft]	14259453
				10 m [32.8 ft]	14259454
	Straight version, cut to length, 5-pin, PUR cable, UL listed, IP67	-20 ... +80 °C [-4 ... +176 °F]	4.75 mm - 5.7 mm [0.18 in - 0.22 in]	2 m [6.6 ft]	14259458
				5 m [16.4 ft]	79100672
				10 m [32.8 ft]	14259472
	Angled version, cut to length, 4-pin, PUR cable, UL listed, IP67	-20 ... +80 °C [-4 ... +176 °F]	5.05 mm - 6 mm [0.2 in - 0.24 in]	2 m [6.6 ft]	14259452
				5 m [16.4 ft]	14293481
				10 m [32.8 ft]	14259455
	Angled version, cut to length, 5-pin, PUR cable, UL listed, IP67	-20 ... +80 °C [-4 ... +176 °F]	5.05 mm - 6 mm [0.2 in - 0.24 in]	2 m [6.6 ft]	79101493
				5 m [16.4 ft]	79100686
				10 m [32.8 ft]	On request

Further cable lengths and cable types are available on request.

Repeater power supply

The analogue input signal is transmitted to the non-hazardous area as galvanically isolated current value. The input signal can be overlaid on the Ex or non-Ex sides with binary signals transmitted bidirectionally.

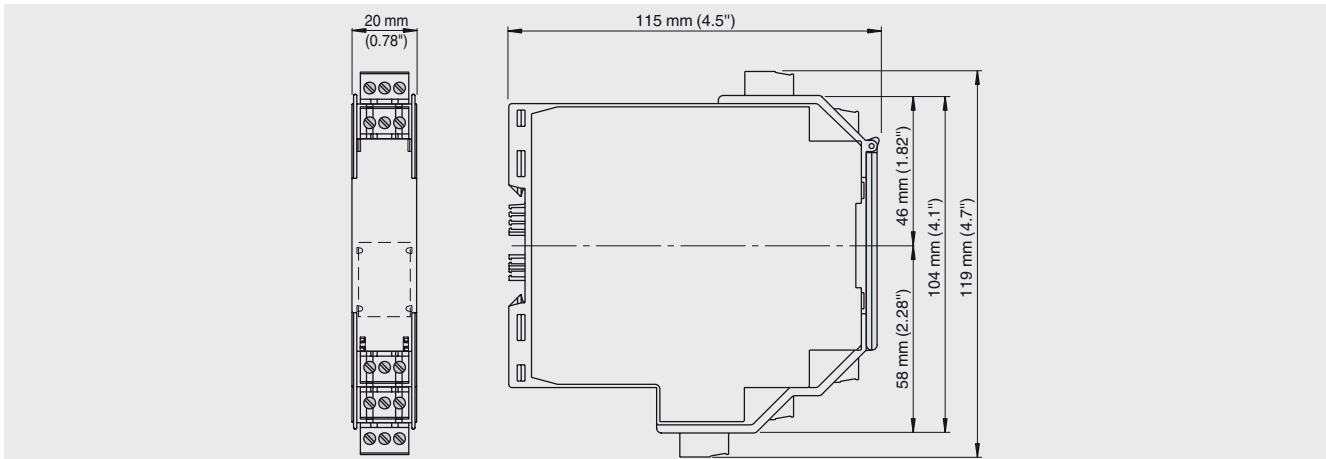

Repeater power supply	Order number
1-channel with DC 24 V supply	14255084

→ WIKA accessories can be found online at www.wika.com.

Ordering information

Model / Rated force / Relative linearity error / Temperature range / Output signal / Electrical connection / Approvals, certificates

© 2019 WIKA Alexander Wiegand SE & Co. KG, all rights reserved.
 The specifications given in this document represent the state of engineering at the time of publishing.
 We reserve the right to make modifications to the specifications and materials.
 In the case of a different interpretation of the translated and the English data sheet, the English wording shall prevail.

