

Capsule pressure gauge, stainless steel

For the process industry, high overload safety

Model 632.51, NS 100 [4"] and 160 [6"]

WIKA data sheet PM 06.06



for further approvals,
see page 6

Applications

- Pressure measurement at very low pressures
- For gaseous, aggressive media, also in aggressive environments
- Robust design and ingress protection IP54, suitable for outdoor use

Special features

- High overload safety up to 50 x full scale value
- Scale ranges from 0 ... 2.5 mbar
- Measuring chamber protected against unauthorised intervention
- Low measured error and influence on function from medium pollution



Capsule pressure gauge, model 632.51

Description

These capsule pressure gauges are used when extremely-low pressures must be displayed on site. The instruments can be overloaded up to 50 times the full scale value without any problems.

The large effective area of the two welded, radially corrugated diaphragms of the capsule element allows the reliable measurement of the smallest pressures. These measuring instruments, made entirely of stainless steel, are suitable for gaseous, aggressive media.

The capsule pressure gauge of model 632.51 has been qualified and manufactured in accordance with EN 837-3.

Functionality

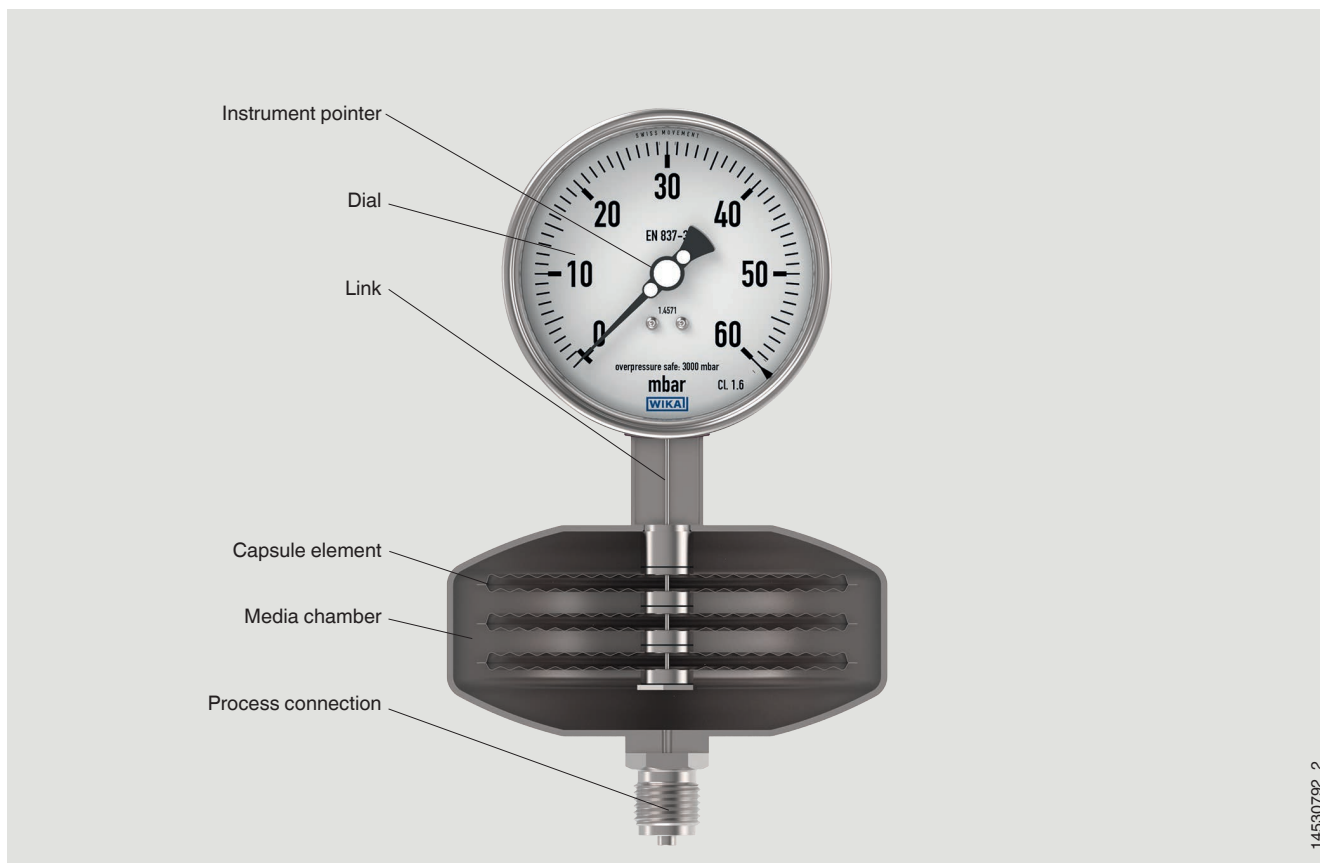

The pressure element, the capsule element, consists of two radially corrugated diaphragms welded at the edge. This increases the effective area of the pressure element compared to diaphragm pressure gauges. Capsule pressure gauges are therefore able to measure extremely low pressures.

The pressure element shown above consists of 3 capsule elements. The link passes through the centre and is attached to the lower capsule element so that unhindered deformation is possible in the media chamber. The pressure element is pressurised from the outside. This results in stroke movements - the measuring travel itself. The measuring travel of the pressure element is transmitted to the movement via the link and displayed by the instrument pointer on the dial.

Overload safety

The capsule element can, through the mutually supporting surfaces of both halves of the capsule element, withstand up to 50 times overload. With a scale range of 0 ... 2.5 mbar, a short-term overpressure of up to 125 mbar is not problematic; the accuracy is not affected.

Specifications

Basic information	
Standard	
Diaphragm and capsule pressure gauges	EN 837-3
→ For information on the "Selection, installation, handling and operation of pressure gauges", see Technical information IN 00.05.	
Nominal size (NS)	<ul style="list-style-type: none"> ■ Ø 100 mm [4"] ■ Ø 160 mm [6"]
Window	Laminated safety glass
Case	Safety level "S1" per EN 837-1: With blow-out device
Material	<ul style="list-style-type: none"> ■ Stainless steel 1.4301 (304) ■ Stainless steel 1.4571 (316 Ti)
Ring	Bayonet ring, stainless steel
Movement	Stainless steel

Measuring element	
Type of measuring element	Capsule element
Materials (wetted)	
Capsule element	Stainless steel 1.4571 (316 Ti)
Measuring chamber	Stainless steel 1.4571 (316 Ti)
Sealing	PTFE
Process connection	Stainless steel 1.4571 (316 Ti)

Accuracy specifications	
Accuracy class	<ul style="list-style-type: none"> ■ 1.6 ■ 1.0¹⁾ ■ 0.6¹⁾
Zero point setting	Setting by means of adjustable pointer
Temperature error	On deviation from the reference conditions at the measuring system: ≤ ±0.6 % per 10 °C [≤ ±0.6 % per 18 °F] of full scale value
Reference conditions	
Ambient temperature	+20 °C [68 °F]

1) Application test required

Scale ranges

mbar	
0 ... 2,5	0 ... 25
0 ... 4	0 ... 40
0 ... 6	0 ... 60
0 ... 10	0 ... 100
0 ... 16	-

mmH ₂ O	
0 ... 25	0 ... 250
0 ... 40	0 ... 400
0 ... 60	0 ... 600
0 ... 100	0 ... 1,000
0 ... 160	-

inH ₂ O	
0 ... 5	0 ... 25
0 ... 10	0 ... 30
0 ... 15	0 ... 40
0 ... 20	-

kPa	
0 ... 1	0 ... 4
0 ... 1,6	0 ... 6
0 ... 2,5	0 ... 10

Vacuum and +/- scale ranges

mbar	
-2.5 ... 0	-8 ... +8
-4 ... 0	-10 ... +6
-6 ... 0	-10 ... +15
-10 ... 0	-10 ... +30
-16 ... 0	-10 ... +50
-25 ... 0	-15 ... +10
-40 ... 0	-15 ... +25
-60 ... 0	-20 ... +5
-100 ... 0	-20 ... +20
-1 ... +5	-20 ... +40
-2 ... +4	-25 ... +15
-2 ... +8	-25 ... +75
-3 ... +3	-30 ... +30
-4 ... +2	-40 ... +20
-4 ... +6	-40 ... +60
-4 ... +12	-50 ... +10
-5 ... +1	-50 ... +50
-5 ... +5	-60 ... +40
-6 ... +10	-75 ... +25
-8 ... +2	-80 ... +20

Other scale ranges on request

Further details on: Scale ranges	
Unit	<ul style="list-style-type: none"> ■ mbar ■ kPa ■ mmH₂O ■ inH₂O Other units on request
Overload safety	50 x full scale value ^{1) 2)}
Vacuum resistance	<ul style="list-style-type: none"> ■ Without ■ 10 x full scale value ²⁾ ■ 3 x full scale value ²⁾
Dial	
Scale layout	<ul style="list-style-type: none"> ■ Single scale ■ Dual scale
Scale colour	Single scale Black
	Dual scale Black/red
Material	Aluminium
Customer-specific version	Other scales, e.g. with red mark, circular arcs or circular sectors, on request → Alternatively, adhesive label set for red and green circular arcs; see data sheet AC 08.03
Instrument pointer	Adjustable pointer, aluminium, black

1) Higher overload safety possible in certain circumstances after application test

2) For vacuum and +/- scale ranges different specifications for overload safety/vacuum resistance apply

Process connection	
Standard	<ul style="list-style-type: none"> ■ EN 837 ■ ANSI / ASME B1.20.1
Size ¹⁾	
EN 837	<ul style="list-style-type: none"> ■ G ½ B ■ M20 x 1.5
ANSI / ASME B1.20.1	½ NPT
Materials (wetted)	
Capsule element	Stainless steel 1.4571 (316 Ti)
Measuring chamber	Stainless steel 1.4571 (316 Ti)
Sealing	PTFE
Process connection	Stainless steel 1.4571 (316 Ti)

1) For further connection threads → See data sheet IN 00.10

Other process connections on request

Operating conditions	
Medium temperature range	+100 °C [+212 °F] maximum
Ambient temperature range	-20 ... +60 °C [-4 ... +140 °F]
Storage temperature range	-40 ... +70 °C [-4 ... 140 °F]
Pressure limitation	
Steady	Full scale value
Fluctuating	0.9 x full scale value
Ingress protection per IEC/EN 60529	IP54

Other versions







- Version for hazardous areas (Ex h)
- Capsule pressure gauge with switch contacts; see data sheet PV 26.06
- Capsule pressure gauge with output signal, see data sheet PV 16.06
- Oil- and grease-free
- For oxygen, oil- and grease-free
- With pre-volume deflagration flame arrester ¹⁾ for connection to zone 0 (EPL Ga); model 910.21; see data sheet AC 91.02

1) Only for instruments with Ex approval

Approvals

Logo	Description	Region
-	CRN Safety (e.g. electr. safety, overpressure, ...)	Canada

Optional approvals

Logo	Description	Region
 	EU declaration of conformity ATEX directive Hazardous areas Gas II 2G h IIC T6 ... T1 Gb X Dust II 2D h IIIC T85°C ... T450°C Db X	European Union
	UKCA Equipment and protective systems intended for use in potentially explosive atmospheres regulations	United Kingdom
	EAC Hazardous areas	Eurasian Economic Community
	Ex Ukraine Hazardous areas	Ukraine
	PAC Kazakhstan Metrology, measurement technology	Kazakhstan
-	MChS Permission for commissioning	Kazakhstan
-	PAC Ukraine Metrology, measurement technology	Ukraine
	PAC Uzbekistan Metrology, measurement technology	Uzbekistan
-	PAC China Metrology, measurement technology	China

Certificates (option)

Certificates	
Certificates	<ul style="list-style-type: none"> ■ 2.2 test report per EN 10204 (e.g. state-of-the-art manufacturing, indication accuracy) ■ 3.1 inspection certificate per EN 10204 (e.g. material proof for wetted metal parts, indication accuracy)
Recommended calibration interval	1 year (dependent on conditions of use)

For approvals and certificates, see website

Dimensions in mm [in]

Model 632.51

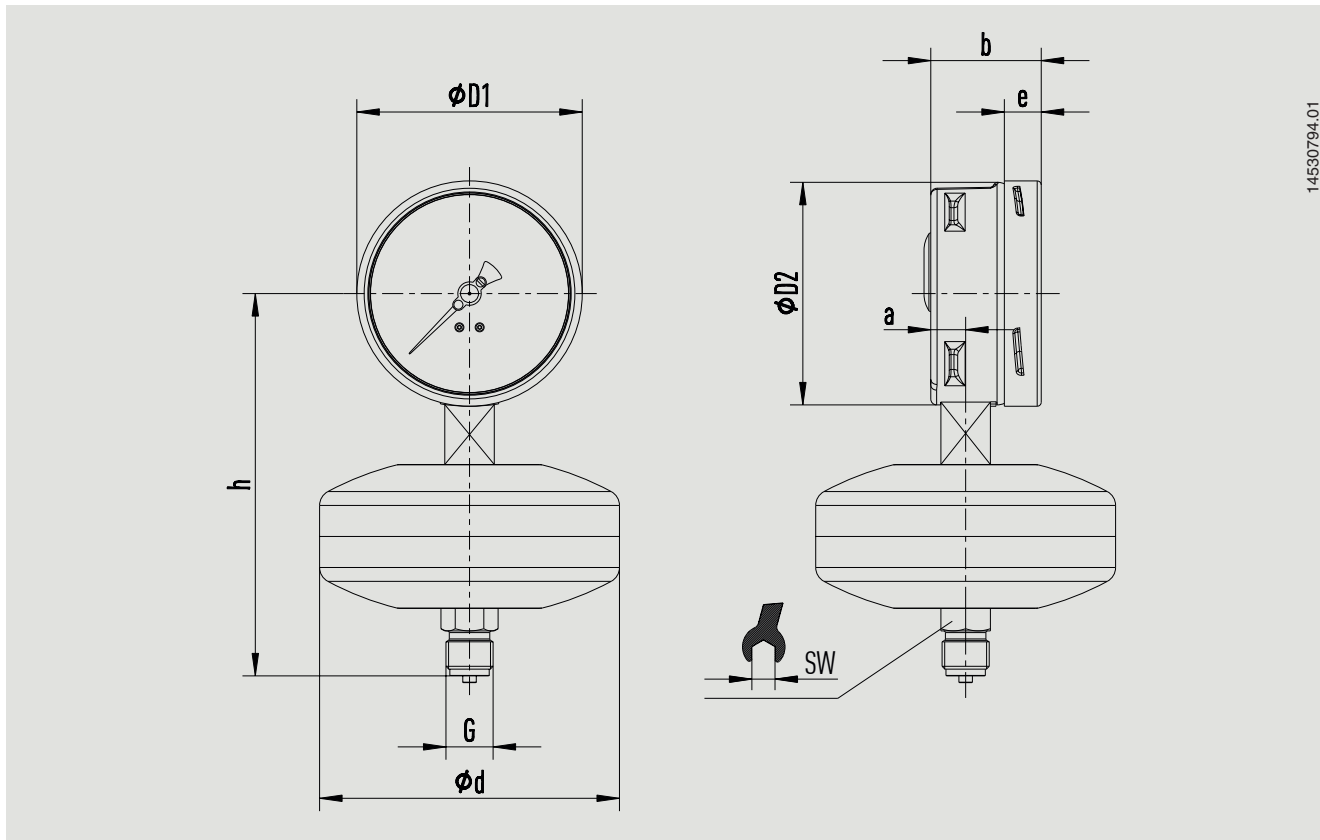







Nominal size 100 [4"]

Process connection G	Dimensions in mm [in]								Weight in kg [lb]
	d	a	b	D1	D2	e	$h \pm 1$ [0.04]	SW	
G ½ B	133 [5.24]	15.5 [0.61]	49.5 [1.95]	101 [3.98]	99 [3.90]	17.5 [0.69]	170 [6.69]	22 [0.87]	1.6 [3.53]
½ NPT	133 [5.24]	15.5 [0.61]	49.5 [1.95]	101 [3.98]	99 [3.90]	17.5 [0.69]	169 [6.65]	22 [0.87]	2.1 [4.63]

Nominal size 160 [6"]

Process connection G	Dimensions in mm [in]								Weight in kg [lb]
	d	a	b	D1	D2	e	$h \pm 1$ [0.04]	SW	
G ½ B	133 [5.24]	15.5 [0.61]	49.5 [1.95]	161 [6.34]	159 [6.26]	17.5 [0.69]	200 [7.87]	22 [0.87]	1.6 [3.53]
½ NPT	133 [5.24]	15.5 [0.61]	49.5 [1.95]	161 [6.34]	159 [6.26]	17.5 [0.69]	199 [7.83]	22 [0.87]	2.1 [4.63]

Accessories and spare parts

Model	Description	Order number
	910.33 Adhesive label set for red and green circular arcs → See data sheet AC 08.03	-
	NS 100 [4"]	14238945
	NS 160 [6"]	14228352
	910.17 Sealings → See data sheet AC 09.08	On request
	910.14 Connection adapters for pressure measuring instruments → See data sheet AC 09.05	On request
	910.15 Syphons → See data sheet AC 09.06	On request
	IV20, IV21 Block-and-bleed valve → See data sheet AC 09.19	On request
	IBF2, IBF3 Monoblock with flange connection → See data sheet AC 09.25	On request
	910.16 Mounting parts for wall and pipe mounting Instrument mounting bracket and adapter piece → See data sheet AC 09.07	On request

Ordering information

Model / Nominal size / Scale range / Process connection / Options

© 08/2009 WIKA Alexander Wiegand SE & Co. KG, all rights reserved.
 The specifications given in this document represent the state of engineering at the time of publishing.
 We reserve the right to make modifications to the specifications and materials.
 In case of a different interpretation of the translated and the English data sheet, the English wording shall prevail.

