

Digital temperature transmitter

For resistance sensors, head- and rail-mounted version

Models T15.H, T15.R

WIKA data sheet TE 15.01



For approvals, see
Seite 7

Applications

- Process industry
- Machine building and plant construction

Special features

- For the connection of Pt100 and Pt1000 sensors in a 2-, 3- or 4-wire connection
- For the connection of reed chains in a potentiometer circuit
- Parameterisation with the WIKAsoft-TT configuration software and electrical connection via quick connector magWIK
- Connection terminals also accessible from the outside
- Accuracy <math>< 0.2\text{ K}</math> (<math>< 0.36\text{ }^\circ\text{F}</math>) / 0.1 %

Description

These temperature transmitters are designed for universal use in plant and machine building, and also in the process industry. They offer high accuracy and excellent protection against electromagnetic influences (EMI). Via the WIKAsoft-TT configuration software and the model PU-548 programming unit, the model T15 temperature transmitters can be parameterised very easily, quickly and with a clear overview.

Besides the selection of the sensor type and the measuring range, the software enables the error signalling operation, damping, several measuring location descriptions and process adjustment to be stored. Furthermore, the WIKAsoft-TT software offers a line recording functionality where the temperature profile for the sensor connected to the T15 can be displayed.

The model T15 transmitter also has diverse supervisory

Fig. left: head-mounted version, model T15.H
Fig. right: rail-mounted version, model T15.R



Configurator



Standard article



functionality, such as the monitoring of the sensor wire resistance and sensor-break detection in accordance with NAMUR NE89 as well as monitoring of the measuring range. Moreover, these transmitters have comprehensive cyclic self-monitoring functionality.

Specifications

Basic information		
	T15.H head-mounted version	T15.R rail-mounted version
Housing		
Material (non-wetted)	PBT plastic, glass-fibre reinforced	Plastic
Weight	Approx. 45 g [approx. 1.6 oz]	Approx. 0.2 kg (approx. 7.1 oz)
Screwdriver	Cross head ('Pozidrive' tip), size 2 (ISO 8764)	Slotted, 3 x 0.5 mm (ISO 2380)
Tightening torque	0.5 Nm	0.5 Nm

Measuring element				
	Sensor type	Max. configurable measuring range	Standard	Min. measuring span (MS)
Resistance sensor	Pt100	-200 ... +850 °C [-328 ... +1,562 °F]	IEC 60751	10 K [50 °F] or 3.8 Ω (greater value applies)
	Pt1000	-200 ... +850 °C [-328 ... +1,562 °F]	IEC 60751	
Potentiometer ¹⁾	Reed chains	0 ... 100 % (= min. 1 ... max. 50 kΩ)	n.a.	10 % (= min. 1 kΩ)
Measuring current during measurement	Max. 0.2 mA (Pt100/Pt1000) Max. 0.1 mA (reed)			
Connection methods	1 sensor in 2-, 3-, 4-wire connection → For further notes, see „Assignment of connection terminals“			

1) R_{total} : 10 ... 50 kΩ

Accuracy specifications

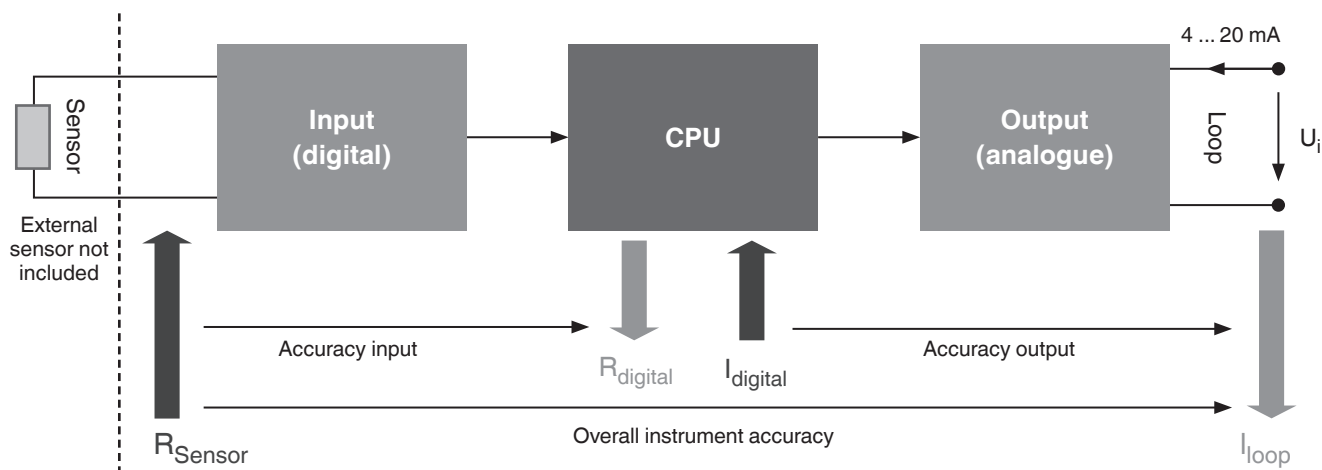

The product-specific accuracy specifications refer to the overall instrument ($\text{Error}_{\text{overall}} = \text{Error}_{\text{input}} + \text{Error}_{\text{output}}$). To determine the total error, all possible types of error must be considered.

These are summarised in the following table.

Accuracy specifications				
Input and output in accordance with IEC 62828				
Input sensor type	Mean temperature coefficient every 10 K ambient temperature deviation from T_{ref}	Measuring deviation at reference conditions ¹⁾ in accordance with DIN EN 60770, NE 145 ²⁾	Influence of auxiliary power every 1 V voltage change from $U_{i,ref}$	Long-term drift per IEC 61298-2 per year
Pt100/Pt1000	$\leq \pm(0.1 \text{ K} + 0.005 \% \text{ MS})$	0.2 K or 0.1 % (greater value applies) MS < 200 K: 0.2 K MS > 200 K: 0.1 % of MS → For further information, see chart „Measuring deviation via span“	$\pm 0.005 \% \text{ of MS}$	< 0.1 % of MS
Potentiometer	$\leq \pm 0.01 \% \text{ of MS}$	Relative accuracy: 0.2 % (R_{part}/R_{total} in %) Absolute accuracy: 1 % (R_{part}/R_{total} in Ω)	$\pm 0.005 \% \text{ of MS}$	< 0.1 % of MS

1) Reference conditions: temperature: 23 °C [73 °F] ± 3 K, relative humidity: 50 - 70 %, ambient pressure: 86 - 106 kPa, auxiliary power $U_{i,ref}$: 24 V

2) In the event of interference caused by high-frequency electromagnetic fields in a frequency range from 80 to 400 MHz, an increased measuring deviation of up to 0.8 % is to be expected. During transient interferences (e.g. burst, surge, ESD) take into account an increased measuring deviation of up to 1.5 %.

Measuring deviation via span

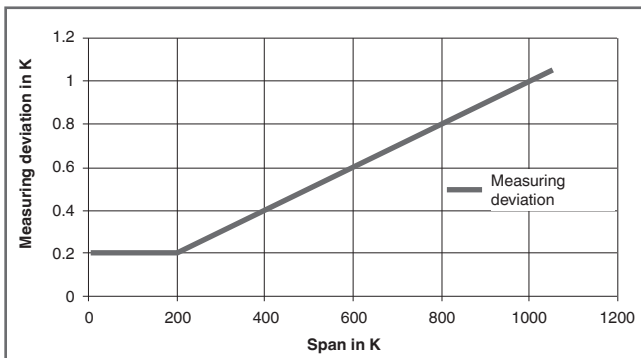

Output signal		
Analogue output	Linear to temperature per IEC 60751	
Output limits per NAMUR NE43	Lower limit	Upper limit
	3.8 mA	20.5 mA
Current value for signalling per NAMUR NE43	Downscale	Upscale
	< 3.6 mA (3.5 mA)	> 20.5 mA (21.5 mA)
Voltage supply		
Auxiliary power U_B	DC 8 ... 35 V	
Load R_A	$R_A \leq (U_B - 8 \text{ V}) / 0.0215 \text{ A}$ with R_A in Ω and U_B in V	
Ex-relevant connection values	See "Safety-relevant characteristics (explosion-protected version)"	
Factory configuration		
Sensor	Pt100	
Connection method	3-wire connection	
Measuring range	0 ... 150 °C [32 ... 302 °F]	
Error signalling	Downscale	
Damping	Off	
Monitoring functions		
Sensor break monitoring	Configurable via software Default: downscale	
Sensor short-circuit monitoring	Configurable via software Default: downscale	
Measuring range monitoring	Monitoring of the set measuring range for upper/lower deviations configurable Standard: deactivated	
Drag pointer (internal temperature of the electronics)	Comparative value in relation to the permissible ambient temperature	
Time response		
Step response time	< 0.6 s (typical < 0.4 s) ¹⁾	
Switch-on time	Max. 3 s	
Damping	Configurable between 1 s and 60 s	
Warm-up time	After approx. 4 minutes the instrument will function to the specifications (accuracy) given in the data sheet	
Measuring rate	Measured value update	With 2-, 4-wire connection approx. 20/s
		With 3-wire connection/potentiometer, approx. 5/s

1) Deviation possible in case of Pt1000 4-wire connection

Electrical connection		
Connection type	Cable	
Wire cross-section		
T15.H head-mounted version	Solid wire	0.14 ... 2.5 mm ² (24 ... 14 AWG)
	Stranded wire with end splice	0.14 ... 1.5 mm ² (24 ... 16 AWG)
T15.R rail-mounted version	Solid wire	0.14 ... 2.5 mm ² (24 ... 14 AWG)
	Stranded wire with end splice	0.14 ... 2.5 mm ² (24 ... 14 AWG)
Lead resistance		
	3- and 4-wire connection	Max. 50 Ω each wire
	2-wire connection	Configurable Input of the values via WIKAsoft-TT

Load diagram

The permissible load depends on the loop supply voltage.

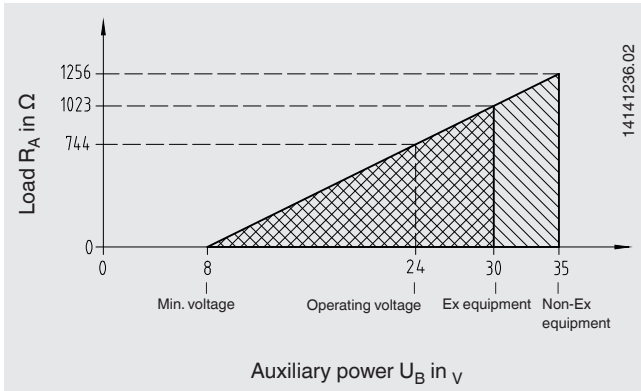

Assignment of connection terminals

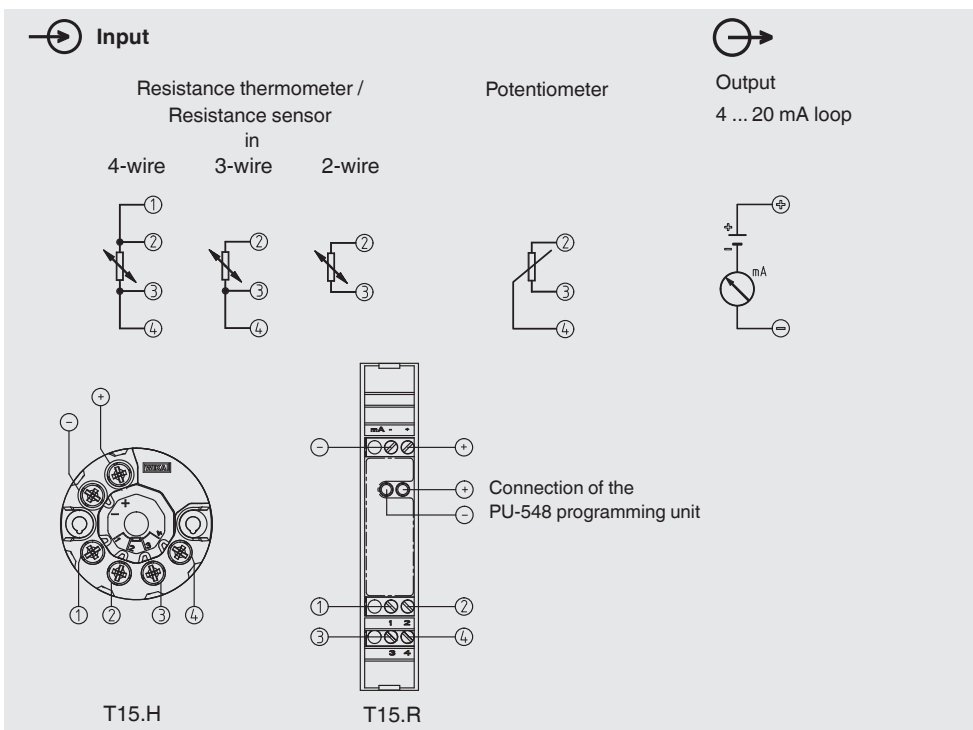

Operating conditions	
Ambient temperature range	{-50} -40 ... +85 {+105} °C [{-58} -40 ... +185 {+221} °F]
Storage temperature range	-40 ... +85 °C [-40 ... +185 °F]
Humidity	
Model T15.H per IEC 60068-2-38:2009	Test max. temperature variation 65 °C [149 °F] / -10 °C [14 °F], 93 % ±3 % relative humidity (condensation permissible)
Model T15.R per IEC 60068-2-30:2005	Test max. temperature 55 °C [131 °F], 95 % relative humidity (condensation permissible in vertical mounting position)
Climate class per IEC 654-1:1993	Cx (-40 ... +85 °C [-40 ... +185 °F], 5 ... 95 % relative humidity)
Salt mist per IEC 68-2-52:1996, IEC 60068-2-52:1996	Severity grade 1
Vibration resistance per IEC 60068-2-6:2008	Test Fc: 10 ... 2,000 Hz; 10 g, amplitude 0.75 mm (0.03 in)
Shock resistance per IEC 68-2-27:2009	
Model T15.H	100 g / 6 ms
Model T15.R	30 g / 11 ms
Free fall per IEC 60721-3-2:1997, DIN EN 60721-3-2:1998	Height of fall 1.5 m [4.9 ft]
Ingress protection of the complete instrument	
Head-mounted version	IP00 (electronics completely potted)
Rail-mounted version	IP20
Electromagnetic compatibility ¹⁾ per DIN EN 55011:2010, DIN EN 61326-2-3:2013, NAMUR NE21:2012, GL 2012 VI Part 7	Emission (group 1, class B) and immunity (industrial environment) [HF field, HF cable, ESD, Burst, Surge]







{ } Items in curved brackets are options for an additional price, not for ATEX versions of the head mounting version and not for T15.R rail-mounted version

1) In the event of interference caused by high-frequency electromagnetic fields in a frequency range from 80 to 400 MHz, an increased measuring deviation of up to 0.8 % is to be expected. During transient interferences (e.g. burst, surge, ESD) take into account an increased measuring deviation of up to 1.5 %.

Approvals

Logo	Description	Region
	EU declaration of conformity	European Union
	EMC Directive	
	EN 61326 emission (group 1, class B) and immunity (industrial environments)	
	RoHS directive	

Optional approvals

Logo	Description	Region
	EU declaration of conformity	European Union
	ATEX directive	
	Hazardous areas	
	- Ex i Zone 0 gas II 1G Ex ia IIC T6 ... T4 Ga Zone 2 gas II 3G Ex ic IIC T6 ... T4 Gc X Zone 20 dust II 1D Ex ia IIIC T135 °C Da - Ex e Zone 2 gas II 3G Ex ec IIC T6 ... T4 Gc X	
	IECEx	International
	Hazardous areas	
	- Ex i Zone 0 gas Ex ia IIC T6 ... T4 Ga Zone 2 gas Ex ic IIC T6 ... T4 Gc X Zone 20 dust Ex ia IIIC T135 °C Da - Ex e Zone 2 gas Ex ec IIC T6 ... T4 Gc X	
	FM	USA
	Hazardous areas Class I, division 1 or 2, groups A/B/C/D, T6 ... T4 Class I, zone 0 or 1, AEx ia IIC T6 ... T4	
	CSA	Canada
	Safety (e.g. electr. safety, overpressure, ...)	
	Hazardous areas Class I, division 1 or 2, groups A/B/C/D, T6 ... T4 Class II, division 1 or 2, groups E/F/G, T6 ... T4 / T135 °C, class III Class I, zone 0 or 1, Ex ia [ia Ga] IIC T6 ... T4 Ga Class I, zone 20 or 21, Ex ia [ia Da] IIIC T135 °C Da	
	EAC	Eurasian Economic Community
	EMC Directive	
	Hazardous areas	
	- Ex i Zone 0 gas 0 Ex ia IIC T4/T5/T6 Zone 1 gas 1 Ex ib IIC T4/T5/T6 Zone 2 gas 2 Ex ic IIC T4/T5/T6 Zone 20 dust DIP A20 Ta 135 °C Zone 21 dust DIP A21 Ta 135 °C - Ex e Zone 2 gas 2 Ex ec IIC T4/T5/T6	
	Ex Ukraine	Ukraine
	Mining	
	Hazardous areas	
	- Ex i Zone 0 gas II 1G Ex ia IIC T6 ... T4 Ga Zone 20 dust II 1D Ex ia IIIC T135 °C Da	
-	PESO	India
	Hazardous areas	
	- Ex i Zone 0 gas Ex ia IIC T6 ... T4 Ga Zone 2 gas Ex ic IIC T6 ... T4 Gc X Zone 20 dust Ex ia IIIC T135 °C Da - Ex e Zone 2 gas Ex ec IIC T6 ... T4 Gc X	

Logo	Description	Region
	PAC Kazakhstan Metrology, measurement technology	Kazakhstan
	PAC Uzbekistan Metrology, measurement technology	Uzbekistan

Certificates

Description	
Certificates	<ul style="list-style-type: none"> ■ 2.2 test report per EN 10204 (e.g. state-of-the-art manufacturing, material proof, indication accuracy) ■ 3.1 inspection certificate per EN 10204 (e.g. material proof for wetted metal parts, indication accuracy, calibration certificate)

→ For approvals and certificates, see website

Safety-related characteristic values (Ex)

- Models T15.x-AI, T15.x-AC

Intrinsically safe connection values for the current loop (4 ... 20 mA)

Protection level Ex ia IIC/IIB/IIA, Ex ia IIIC or Ex ic IIC/IIB/IIA

Safety-related characteristic values (Ex)	Models T15.x-AI, T15.x-AC		Model T15.x-AI
	Gas hazardous application		Dust hazardous application
Connection values			
Terminals	+ / -		+ / -
Max. voltage U_i	DC 30 V		DC 30 V
Max. current I_i	130 mA		130 mA
Max. power P_i	800 mW		750/650/550 mW
Effective internal capacitance C_i	18.4 nF		18.4 nF
Effective internal inductance L_i	20 μ H		20 μ H
Connection values of sensor circuit			
Terminals	1 - 4		1 - 4
Max. voltage U_0	DC 30 V		DC 30 V
Max. current I_0	8.2 mA		8.2 mA
Max. power P_0	62 mW		62 mW
Effective internal capacitance C_i	IIC	30 nF ¹⁾	180 nF ¹⁾
Effective internal capacitance C_i	IIB IIC	0.520 μ F ¹⁾	1.37 μ F ¹⁾
Effective internal capacitance C_i	IIA	1.70 μ F ¹⁾	5.40 μ F ¹⁾
Max. external inductance L_0	IIC	1 mH	2 mH
Max. external inductance L_0	IIB IIC	1 mH	2 mH
Max. external inductance L_0	IIA	1 mH	2 mH
Characteristic curve	Linear		

1) Internal L and C have already been considered

Application	Ambient temperature range	Temperature class	Power P _i
Group II	-40 °C [-40 °F] ≤ T _a ≤ +85 °C [+185 °F]	T4	800 mW
	-40 °C [-40 °F] ≤ T _a ≤ +70 °C [+158 °F]	T5	800 mW
	-40 °C [-40 °F] ≤ T _a ≤ +55 °C [+131 °F]	T6	800 mW
Group IIIC	-40 °C [-40 °F] ≤ T _a ≤ +40 °C [+104 °F]	N/A	750 mW
	-40 °C [-40 °F] ≤ T _a ≤ +75 °C [+167 °F]	N/A	650 mW
	-40 °C [-40 °F] ≤ T _a ≤ +85 °C [+185 °F]	N/A	550 mW

N / A = not applicable

Legend

U_o: Maximum voltage of any conductor against the other three conductors

I_o: Maximum output current for the least favourable connection of the internal current limiting resistors

P_o: U_o x I_o divided by 4 (linear characteristic)

■ Model T15.x-AE

Power and signal circuit (4 ... 20 mA loop)

Protection level Ex ec IIC/IIB/IIA

Safety-related characteristic values (Ex)	Model T15.x-AE
	Gas hazardous application
Connection values	
Terminals	+ / -
Max. voltage U _i	DC 35 V
Max. current I _i	21.5 mA
Connection values of sensor circuit	
Protection level	Ex ec IIC/IIB/IIA
Terminals	1 - 4
Max. power P _o	<ul style="list-style-type: none"> ■ 0.33 mW ■ DC 3.3 V ■ 0.1 mA

Application	Ambient temperature range	Temperature class
Group II	-40 °C [-40 °F] ≤ T _a ≤ +85 °C [+185 °F]	T4
	-40 °C [-40 °F] ≤ T _a ≤ +70 °C [+158 °F]	T5
	-40 °C [-40 °F] ≤ T _a ≤ +55 °C [+131 °F]	T6
Group IIIC	-40 °C [-40 °F] ≤ T _a ≤ +40 °C [+104 °F]	N/A
	-40 °C [-40 °F] ≤ T _a ≤ +75 °C [+167 °F]	N/A
	-40 °C [-40 °F] ≤ T _a ≤ +85 °C [+185 °F]	N/A

Dimensions in mm [in]

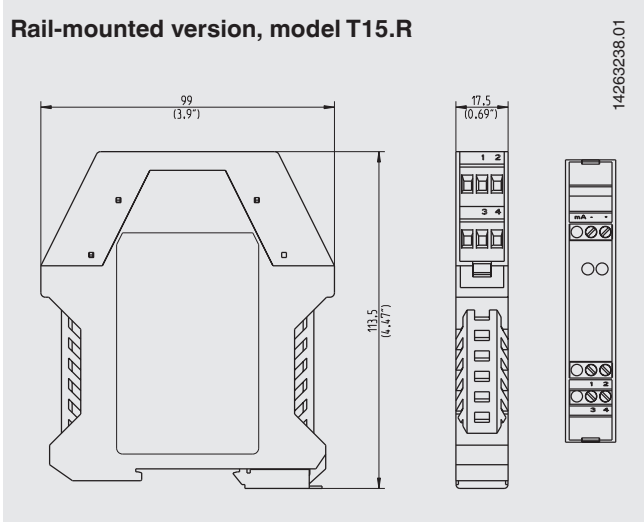
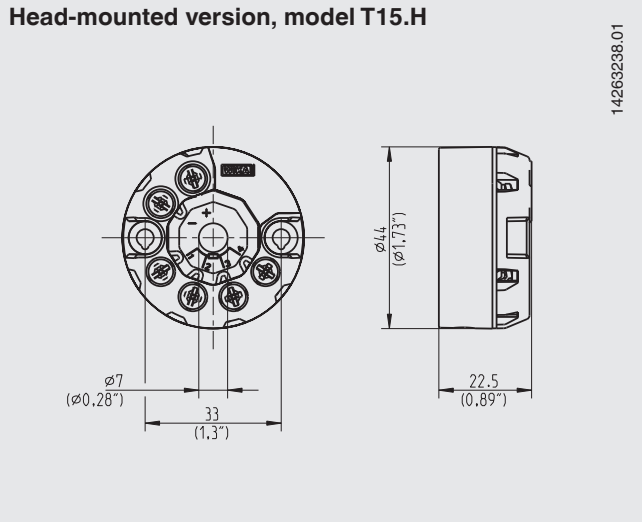

The dimensions of the head-mounted transmitter match the form B DIN connection heads with extended mounting space, e.g. WIKA model BSZ.

The transmitters in rail mounting cases are suitable for all standard rails in accordance with IEC 60715.

Configuration

Connecting the PU-548 programming unit

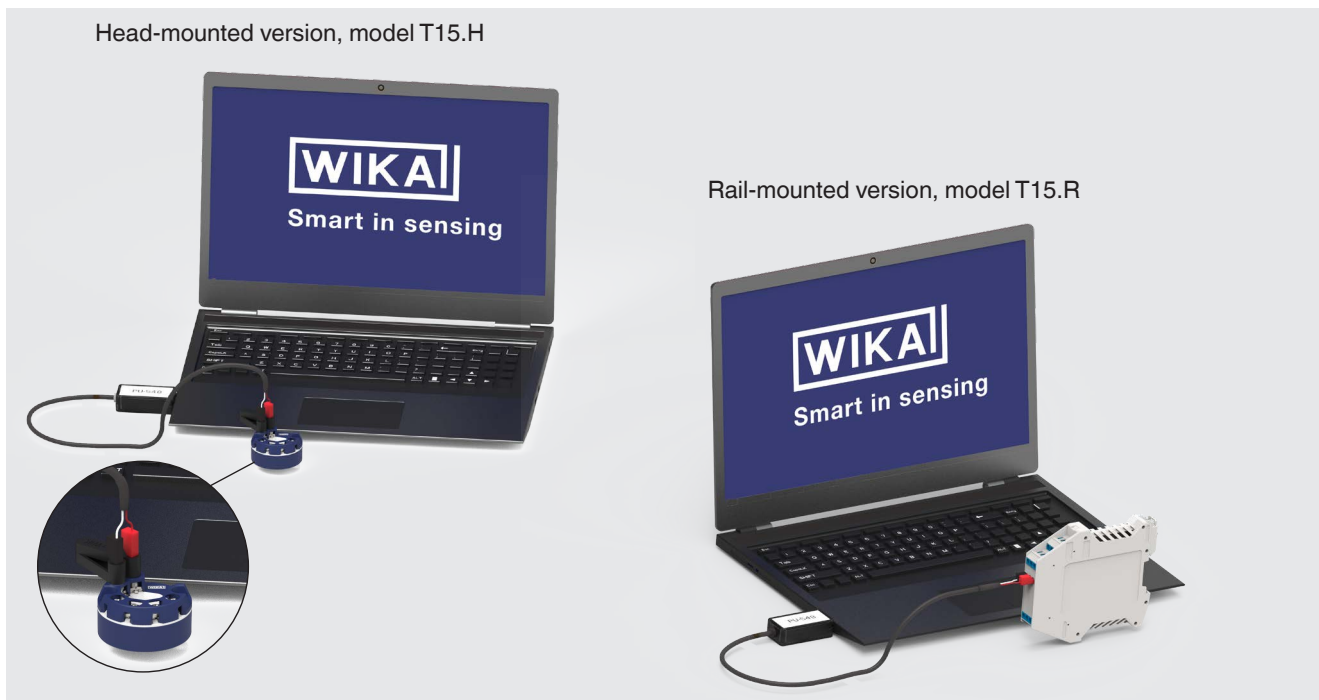



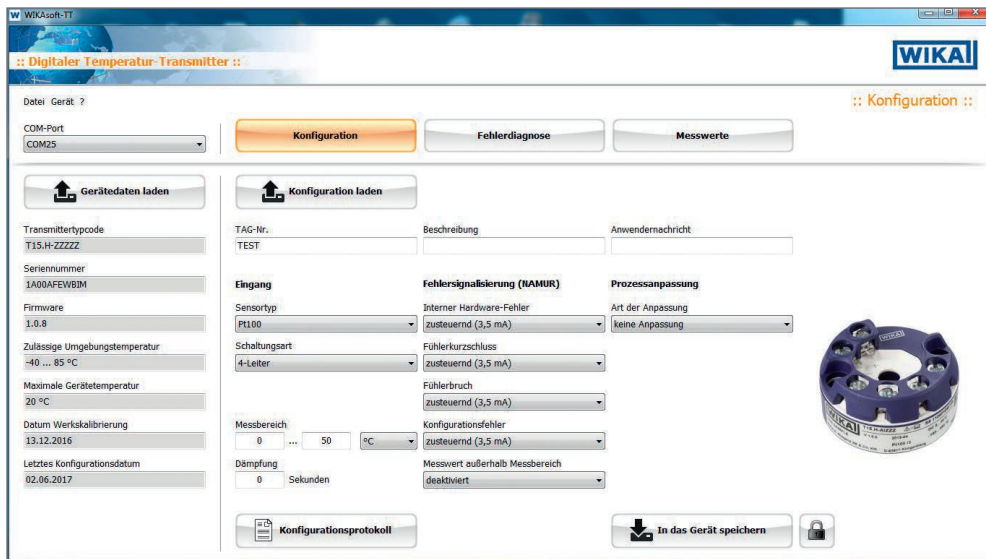

For direct communication via the serial interface of a PC/notebook, a model PU-548 programming unit is needed (see “Accessories”).

Configuration software WIKAsoft-TT



Accessories and spare parts

Model	Description	Order number
 <p>Programming unit model PU-548</p>	<p>Programming unit for USB interface for use with the WIKAsoft-TT configuration software</p> <p>Easy to use</p> <p>LED status display</p> <p>Compact design</p> <p>No further voltage supply needed, neither for the programming unit nor for the transmitter</p> <p>Incl. 1 model magWIK magnetic quick connector</p>	14231581
 <p>Adapter</p>	<p>Suitable for TS 35 per DIN EN 60715 (DIN EN 50022) or TS 32 per DIN EN 50035</p> <p>Material: plastic / stainless steel</p> <p>Dimensions: 60 x 20 x 41.6 mm</p>	3593789
 <p>Adapters</p>	<p>Suitable for TS 35 per DIN EN 60715 (DIN EN 50022)</p> <p>Material: steel, tin-plated</p> <p>Dimensions: 49 x 8 x 14 mm</p>	3619851
 <p>Magnetic quick connector, model magWIK</p>	<p>Replacement for crocodile clips and HART® terminals</p> <p>Fast, safe and secure electrical connection</p> <p>For all configuration and calibration processes</p>	14026893

Ordering information

Model / Explosion protection / Additional approvals / Permissible ambient temperature / Configuration / Certificates / Options



© 10/2015 WIKA Alexander Wiegand SE & Co. KG, all rights reserved.
 The specifications given in this document represent the state of engineering at the time of publishing.
 We reserve the right to make modifications to the specifications and materials.
 In case of a different interpretation of the translated and the English data sheet, the English wording shall prevail.

